

Thomas GRIMSEY (c1650 – ?) m 1686 Mary BLAND (c1650 – ?)

G9

704  
Thomas GRIMSEY  
1650 – ?

- 1687 — Thomas m 1716 Elizabeth WARREN
- 1689 — John m 1710 Mary HOLDEN
- 1693 — Mary

G8

John GRIMSEY (1689 – 1736) m 1710 Mary HOLDEN (c1689 – 1752)

- 1711 — Mary m 1737 Henry HAIST
- 1713 — Jane
- 1714 – 1802 — John m 1751 Elizabeth SCHOFIELD
- 1715 — Robert m 1751 Martha LOTT
- 1718 — Joseph m 1751 Susannah GILLBUN
- 1721 — Elizabeth
- 1723 — William
- 1725 — Elizabeth
- 1727 — Isaac
- 1731 — Sarah
- 1735 — Elizabeth

352  
John GRIMSEY  
1689 – 1736

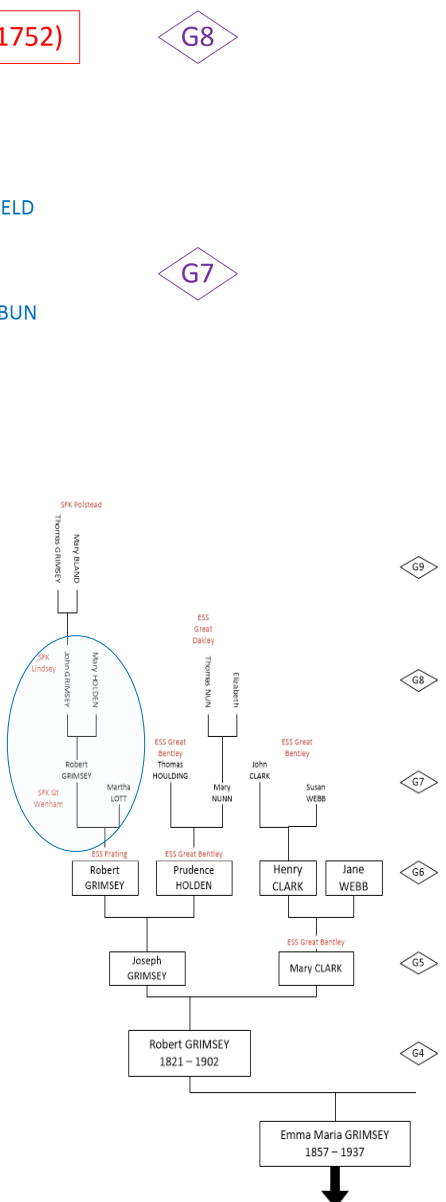

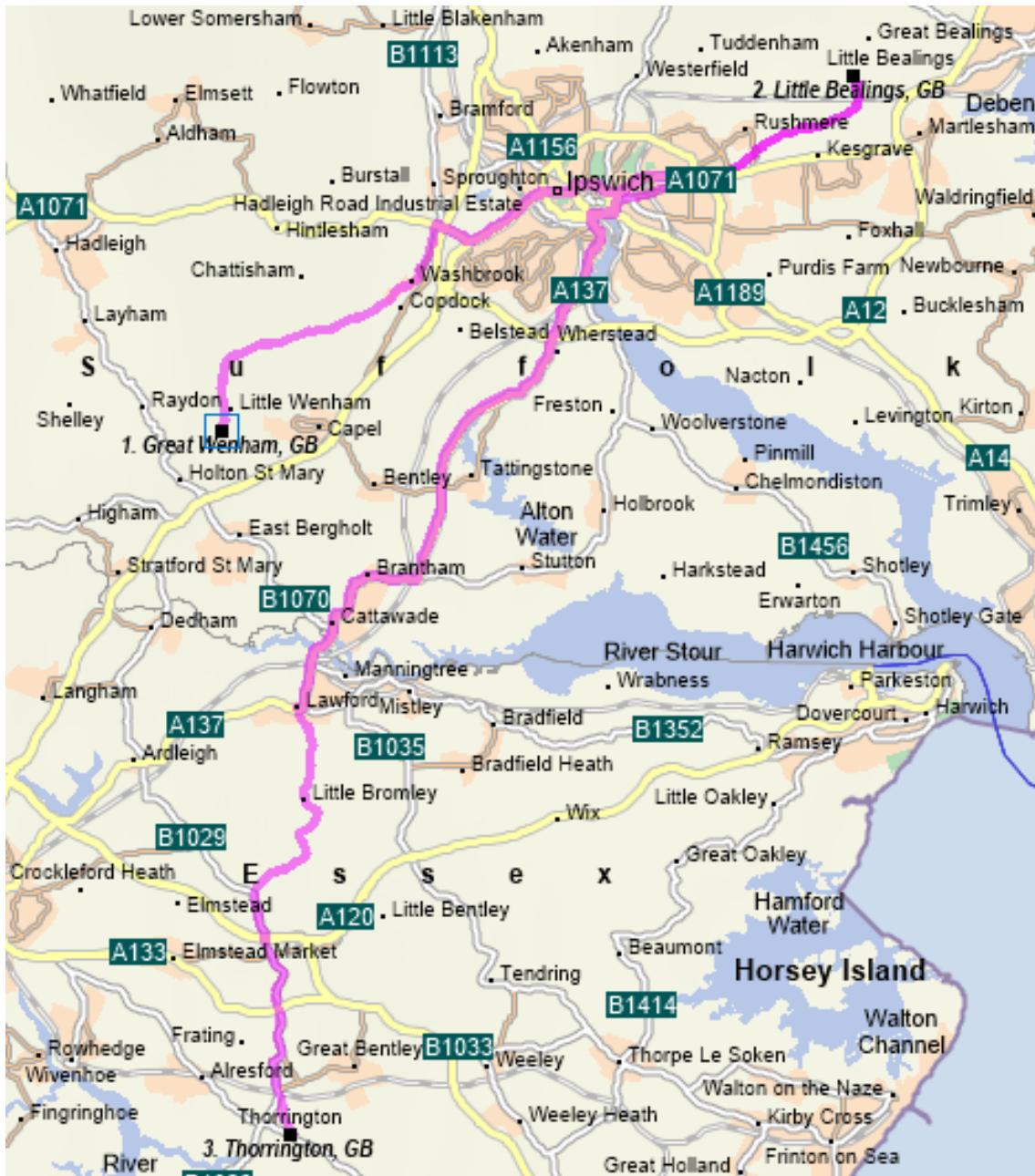

Robert GRIMSEY (1717 – 1763) m 1751 Martha LOTT (1717 – 1785)

1752 – 1813	—	John m 1777 Hannah ALLEN	<i>1 daughter</i>
1754 – 1755	—	Robert	
1755 – 1824	—	Robert m 1779 Prudence HOLDEN	
1757 – 1757	—	Joseph	
1758 – 1814	—	Isaac m 1803 Susan GOLDACRE	<i>1 dau, 1 son</i>
1760 – ?	—	Sarah m 1782 Richard HOULDING	<i>no children</i>
1763 – 1764	—	Lucy	

176  
Robert GRIMSEY  
1717 – 1763

Robert GRIMSEY (1717 – 1763) m 1751 Martha LOTT (1717 – 1785)

1752 – 1813	—	John m 1777 Hannah ALLEN	<i>1 daughter</i>
1754 – 1755	—	Robert	
1755 – 1824	—	Robert m 1779 Prudence HOLDEN	
1757 – 1757	—	Joseph	
1758 – 1814	—	Isaac m 1803 Susan GOLDACRE	<i>1 dau, 1 son</i>
1760 – ?	—	Sarah m 1782 Richard HOULDING	<i>no children</i>
1763 – 1764	—	Lucy	

176  
Robert GRIMSEY  
1717 – 1763

**Robert GRIMSEY (1717 – 1763) m 1751 Martha LOTT (1717 – 1785)**

- 1752 – 1813 — John m 1777 Hannah ALLEN 1 daughter
- 1754 – 1755 — Robert
- 1755 – 1824 — Robert m 1779 Prudence HOLDEN
- 1757 – 1757 — Joseph
- 1758 – 1814 — Isaac m 1803 Susan GOLDACRE 1 dau, 1 son
- 1760 – ? — Sarah m 1782 Richard HOULDING no children
- 1763 – 1764 — Lucy

176  
Robert GRIMSEY  
1717 – 1763

**Isaac GRIMSEY (1758 – 1814) m 1803 Susan GOLDACRE (? – ?)**

- 1804 – 1804 — Isaac
- 1805 – 1856 — Susanne m 1826 Nicholas GRIMSEY

0880  
Isaac GRIMSEY  
1758 – 1814

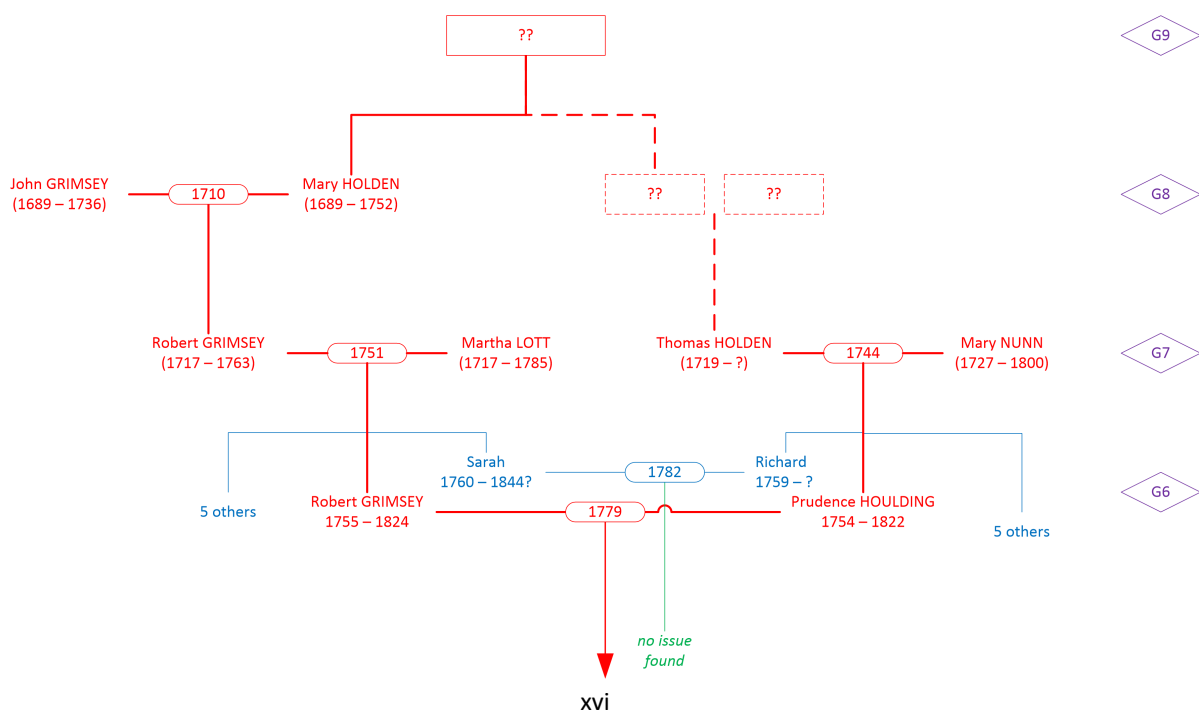

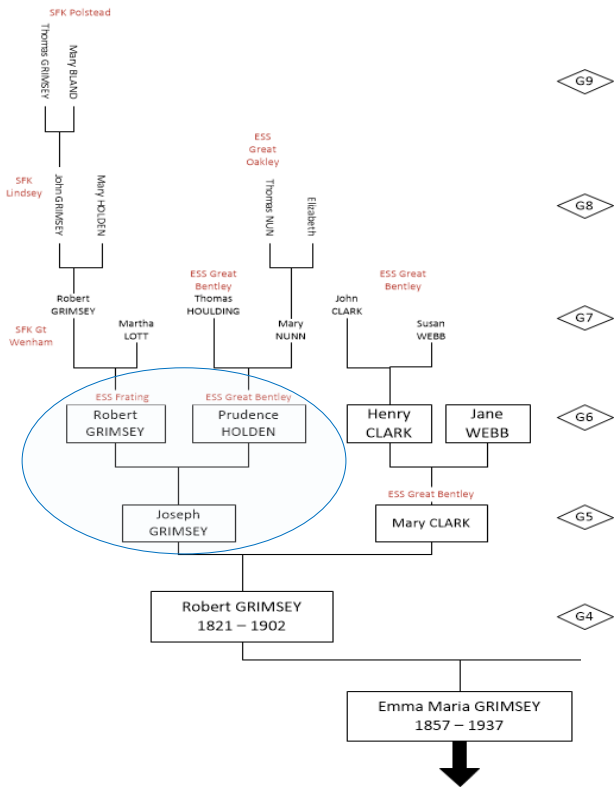

**Robert GRIMSEY (1755 – 1824) m 1779 Prudence HOLDEN (1754 – 1822)**

G6

- 1779 – 1828 — Robert m 1820 Susan GRIMSEY
- 1781 – 1859 — John m 1810 Mary PINNER
- 1783 – 1849 — Isaac m (1) 1809 Mary BENNEWORTH  
m (2) 1814 Susannah HUMM
- 1784 – 1867 — Lucy m 1815 James TILLET
- 1787 – 1875 — Martha m 1815 Bruce PULFIER
- 1790 – 1865 — David
- 1790 – 1877 — George m 1813 Sarah ROWLAND
- 1792 – 1855 — Joseph m 1815 Mary CLARK
- 1794 – 1808 — Aaron Lot
- 1797 – 1864 — Nicholas m 1826 Susanna GRIMSEY
- 1799 – 1871 — Prudence m (1) 1820 Josiah GUNN  
m (2) 1860 John HEARN

G5

088  
Robert GRIMSEY  
1755 – 1824

Robert GRIMSEY (1755 – 1824) m 1779 Prudence HOLDEN (1754 – 1822)

G6

1779 – 1828 — Robert m 1820 Susan GRIMSEY  
1781 – 1859 — John m 1810 Mary PINNER  
1783 – 1849 — Isaac m (1) 1809 Mary BENNEWORTH  
m (2) 1814 Susannah HUMM  
1784 – 1867 — Lucy m 1815 James TILLET  
1787 – 1875 — Martha m 1815 Bruce PULFIER  
1790 – 1865 — David  
1790 – 1877 — George m 1813 Sarah ROWLAND  
1792 – 1855 — Joseph m 1815 Mary CLARK  
1794 – 1808 — Aaron Lot  
1797 – 1864 — Nicholas m 1826 Susanna GRIMSEY  
1799 – 1871 — Prudence m (1) 1820 Josiah GUNN  
m (2) 1860 John HEARN

G5

088  
Robert GRIMSEY  
1755 – 1824



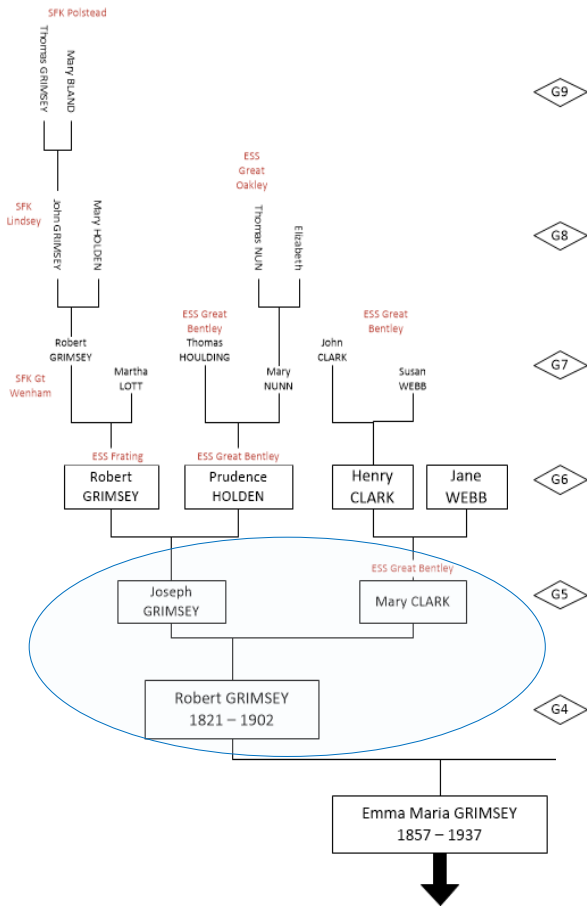

Joseph GRIMSEY (1792 – 1855) m 1815 Mary CLARK (1798 – 1854)

G5

- 1815 – ? — Joseph m Maria BACON
- 1817 – 1818 — Thomas
- 1820 – 1895 — James m 1846 Caroline GILDERS
- 1821 – 1902 — Robert m 1847 Phoebe COOPER
- 1824 – ? — Mary Ann m 1843 Joseph ROSE
- 1824 – ? — Charlotte
- 1828 – 1872 — Ann (Nancy) m 1846 Samuel ROSE
- 1830 – ? — Elizabeth
- 1833 – 1897 — Emma m 1852 John KING
- 1841 – 1915 — George Samuel m 1864 Martha GARNETT

G4

044  
Joseph GRIMSEY  
1792 – 1855

Joseph GRIMSEY (1792 – 1855) m 1815 Mary CLARK (1798 – 1854)

G5

1815 – ? — Joseph m Maria BACON  
1817 – 1818 — Thomas  
1820 – 1895 — James m 1846 Caroline GILDERS  
1821 – 1902 — Robert m 1847 Phoebe COOPER  
1824 – ? — Mary Ann m 1843 Joseph ROSE  
1824 – ? — Charlotte  
1828 – 1872 — Ann (Nancy) m 1846 Samuel ROSE  
1830 – ? — Elizabeth  
1833 – 1897 — Emma m 1852 John KING  
1841 – 1915 — George Samuel m 1864 Martha GARNETT

G4

044  
Joseph GRIMSEY  
1792 – 1855

Robert GRIMSEY (1821 – 1902) m 1847 Phoebe COOPER (1826 – 1900)

G4

- 1847 – 1898 — Eliza
- 1850 – 1928 — Octavia Jane m 1873 Stephen CAREY
- 1855 – 1918 — Ellen m 1874 Josiah WHENT
- 1857 – 1937 — Emma Maria m 1880 George HUMPHRIES
- 1860 – 1936 — Joseph Thomas m 1881 Emily MARSH
- 1863 – 1864 — Ruth
- 1866 – 1919 — Robert m 1889 Mary GOSLING
- 1869 – 1870 — Wille
- 1869 – 1870 — Ruth

G3

022  
Robert GRIMSEY  
1821 – 1902

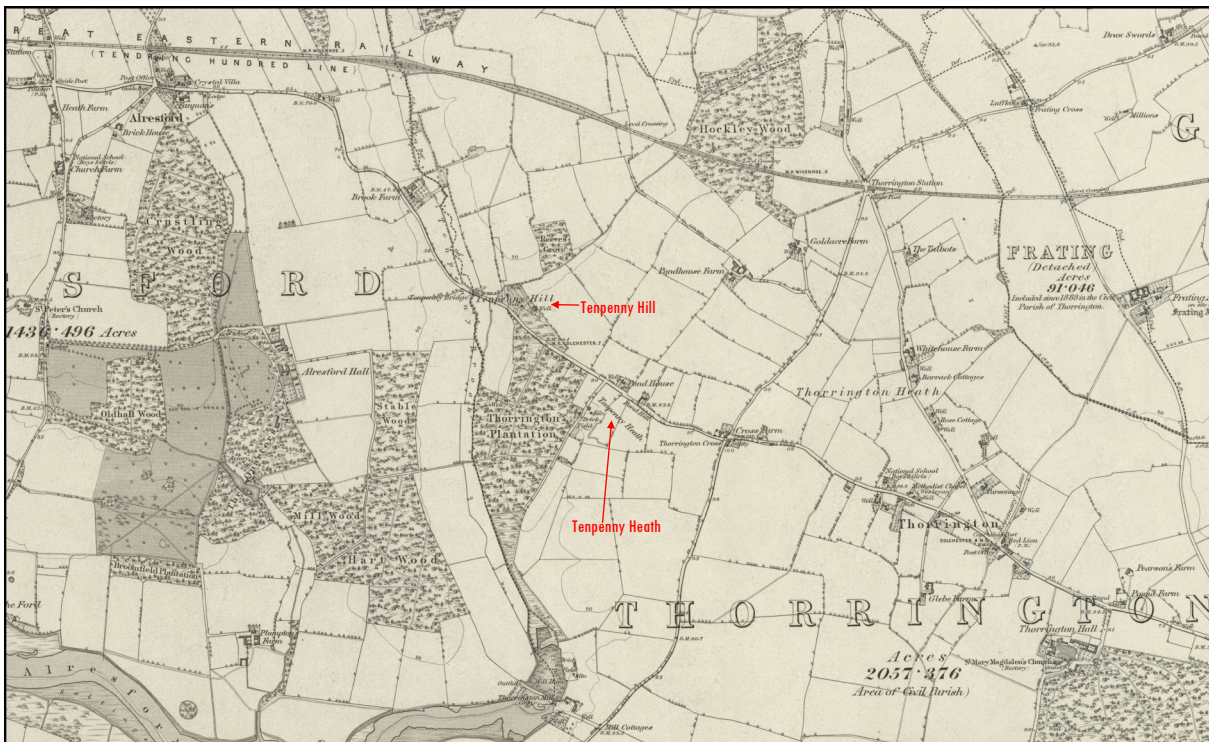
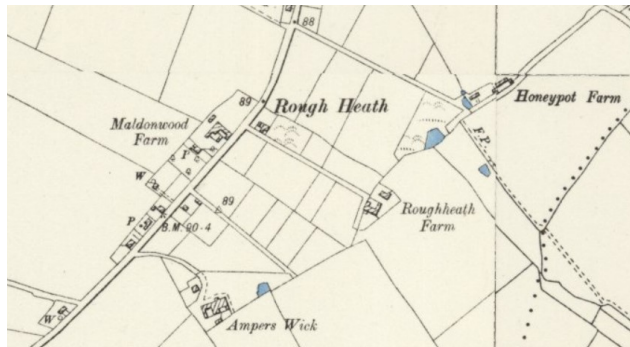

Robert GRIMSEY (1821 – 1902) m 1847 Phoebe COOPER (1826 – 1900)

G4

1847 – 1898 — Eliza  
1850 – 1928 — Octavia Jane m 1873 Stephen CAREY  
1855 – 1918 — Ellen m 1874 Josiah WHENT  
1857 – 1937 — Emma Maria m 1880 George HUMPHRIES  
1860 – 1936 — Joseph Thomas m 1881 Emily MARSH  
1863 – 1864 — Ruth  
1866 – 1919 — Robert m 1889 Mary GOSLING  
1869 – 1870 — Wille  
1869 – 1870 — Ruth

G3

022  
Robert GRIMSEY  
1821 – 1902

Robert GRIMSEY (1821 – 1902) m 1847 Phoebe COOPER (1826 – 1900)

G4

- 1847 – 1898 — Eliza
- 1850 – 1928 — Octavia Jane *m 1873 Stephen CAREY*
- 1855 – 1918 — Ellen *m 1874 Josiah WHENT*
- 1857 – 1937 — Emma Maria *m 1880 George HUMPHRIES*
- 1860 – 1936 — Joseph Thomas *m 1881 Emily MARSH*
- 1863 – 1864 — Ruth
- 1866 – 1919 — Robert *m 1889 Mary GOSLING*
- 1869 – 1870 — Wille
- 1869 – 1870 — Ruth

G3

022  
Robert GRIMSEY  
1821 – 1902

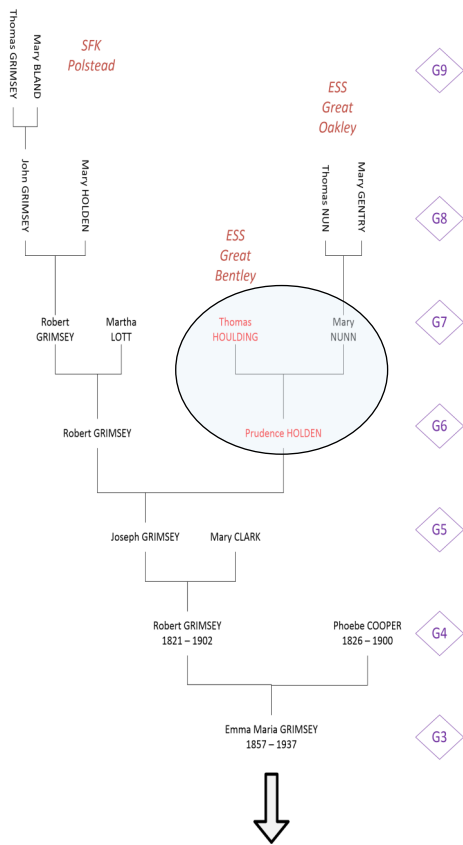

Thomas HOULDING (1719 - ?) m 1744 Mary NUNN (1727 - 1800)

- 1749 - ? — John
- 1751 - 1755 — Estosidela
- 1753 - ?1760 — David
- 1754 - 1822 — Prudence
- 1754 - ? — Ann
- 1758 - 1758 — Richard
- 1759 - ? — Richard

178  
Thomas HOULDING  
1719 - ?

Grimsey—Holden intermarriage

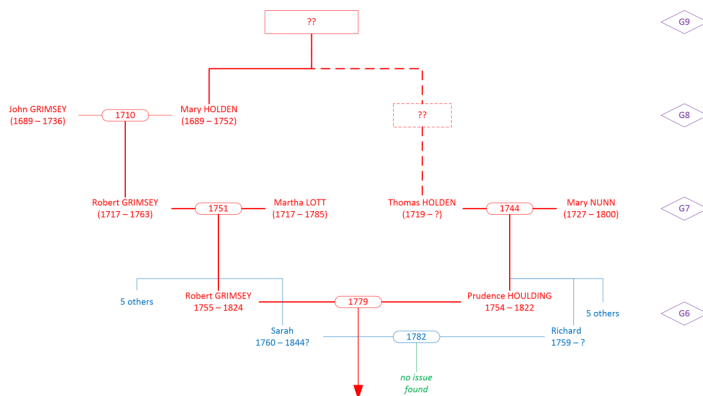



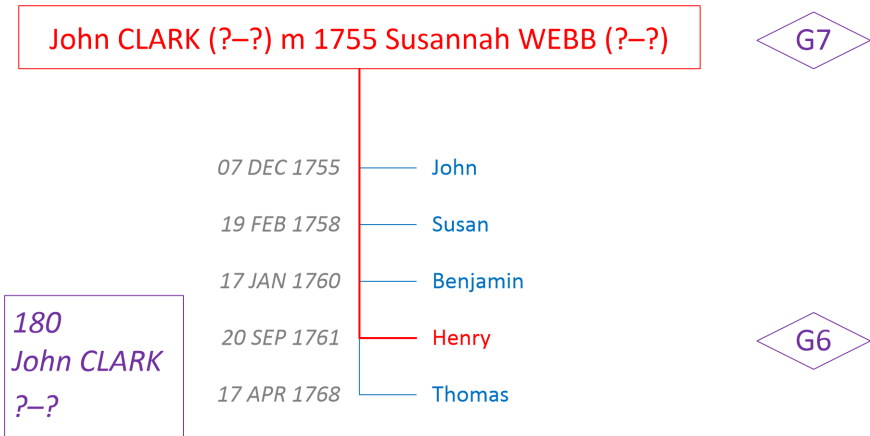
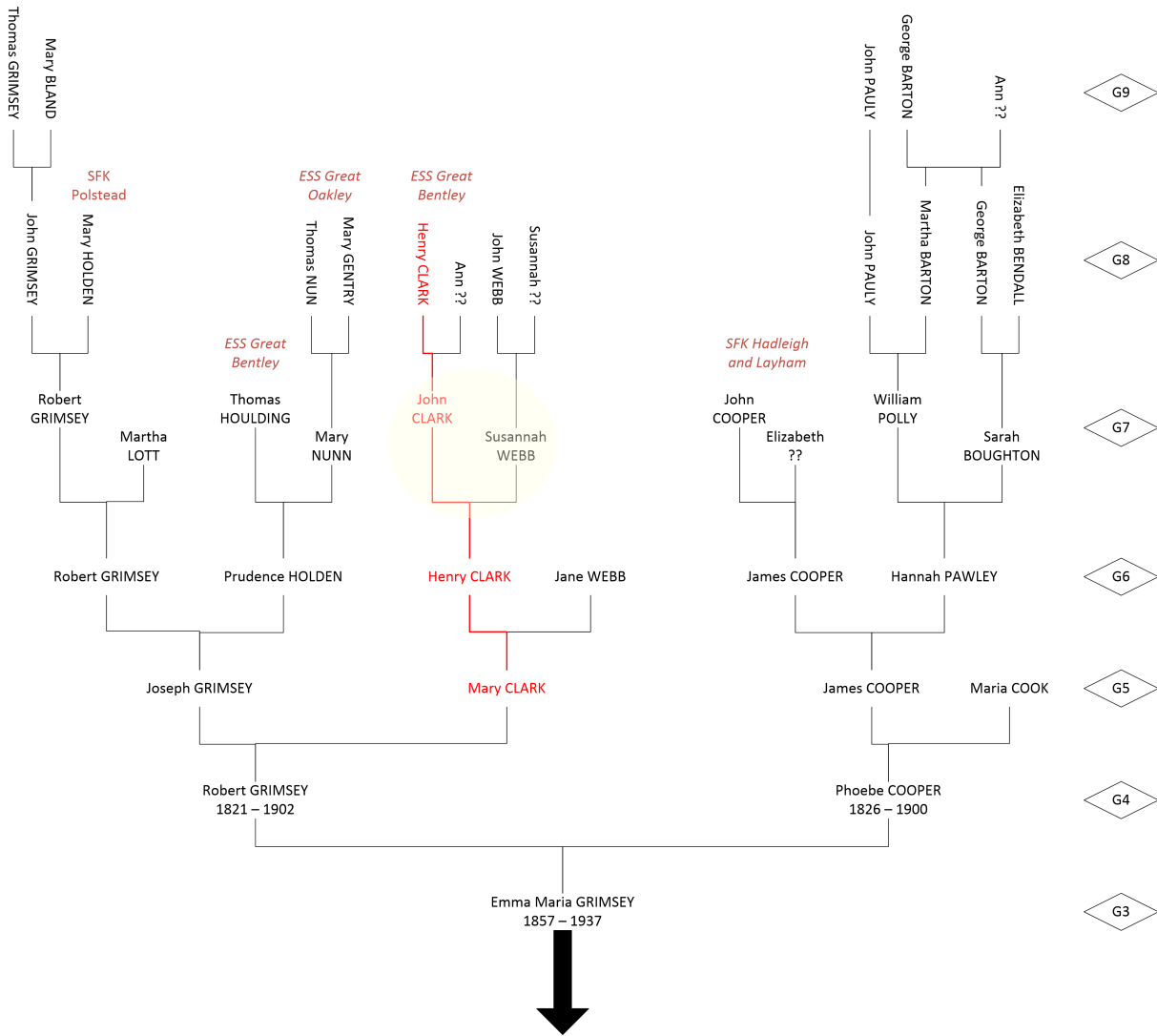



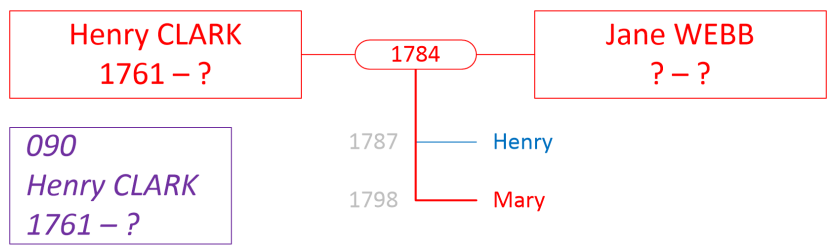
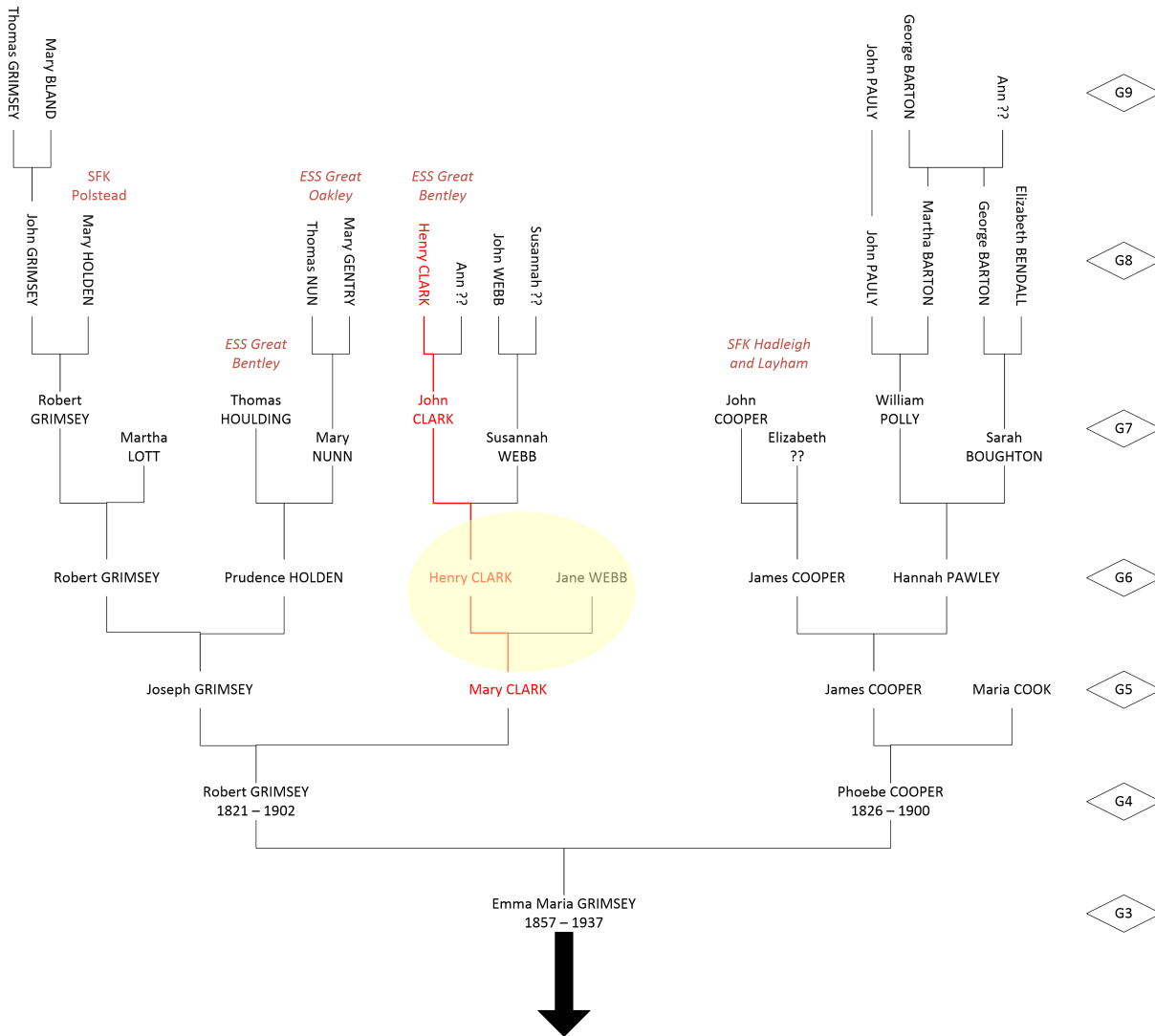

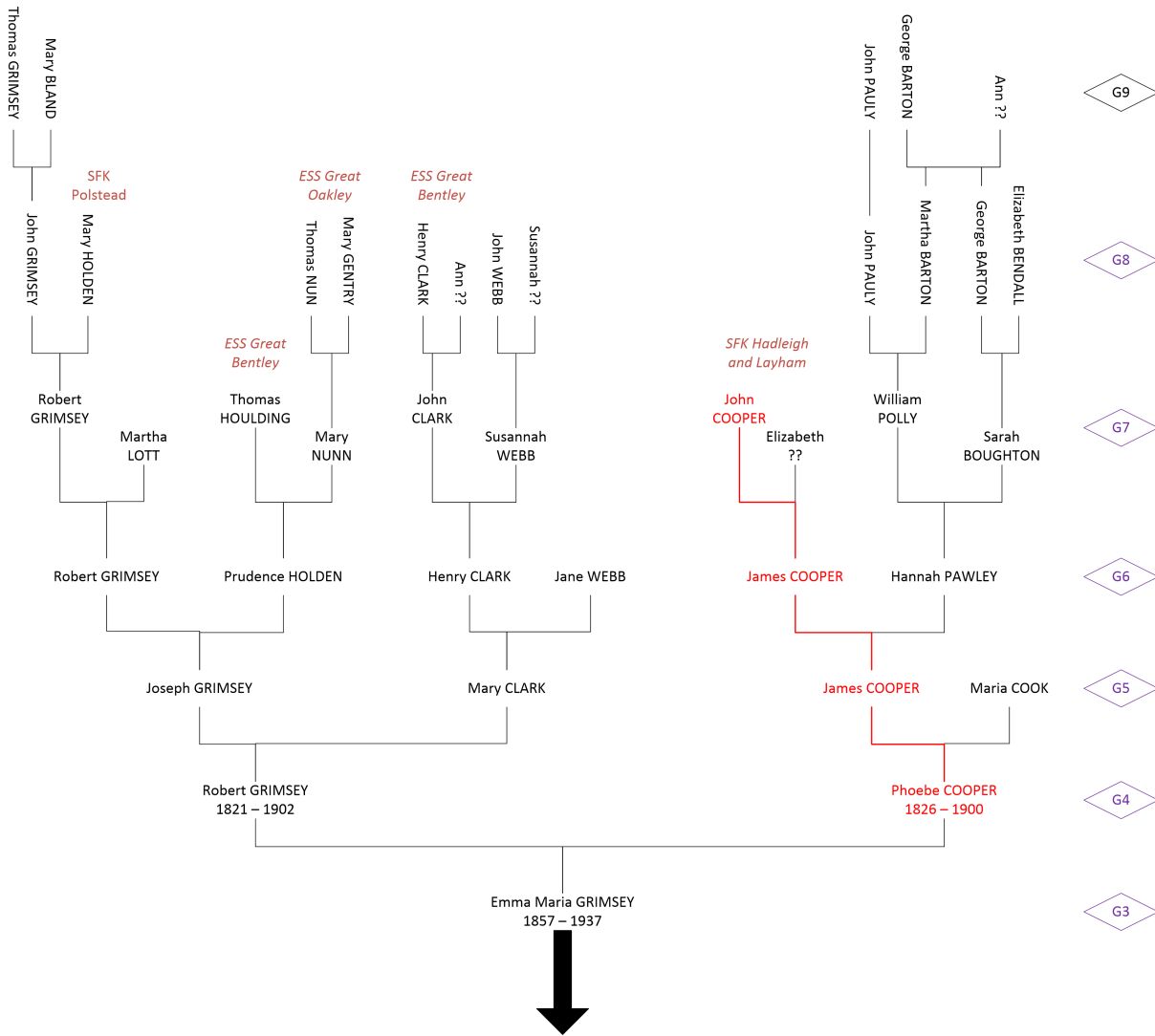

John COOPER m Elizabeth ??

G7

1733 — Robert m 1761 Anne AYERS

1735 — Mary

1737 — Jane

1744 — James

1747 — Judith m 1774 James FALLOWS

184  
John COOPER  
? – ?

G6

James COOPER (1744 – 1799)

1767

Hannah PAWLEY / POLLY (1745 – 1800)

- 1767 – ? — Mary m 1791 John PAWLEY
- 1770 – ? — William
- 1772 – ? — Susan m 1795 William MANN
- 1775 – ? — Sarah
- 1779 – ? — James
- 1783 – ? — John m 1821 Elizabeth HALSEY
- 1786 – ? — Thomas

092  
James COOPER  
1744 – 1799

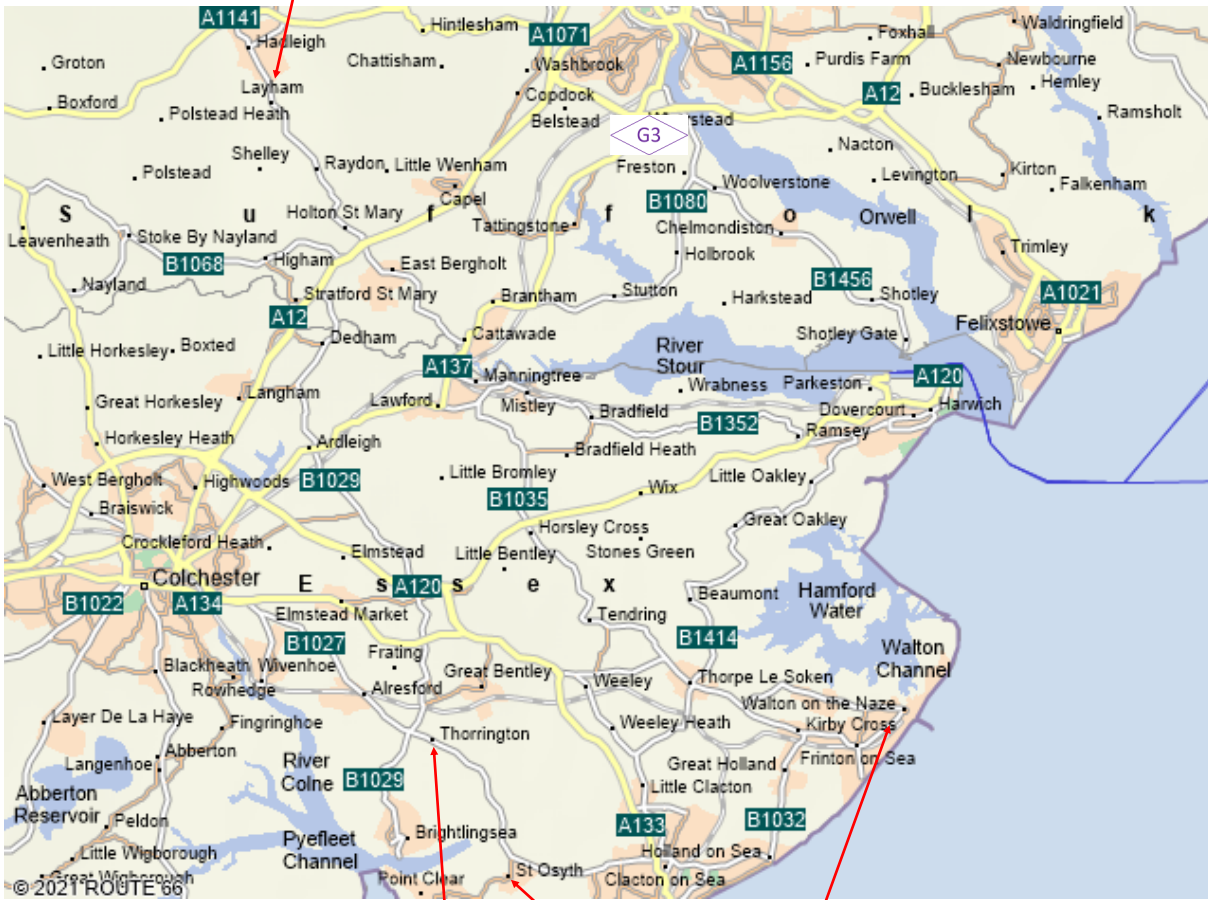
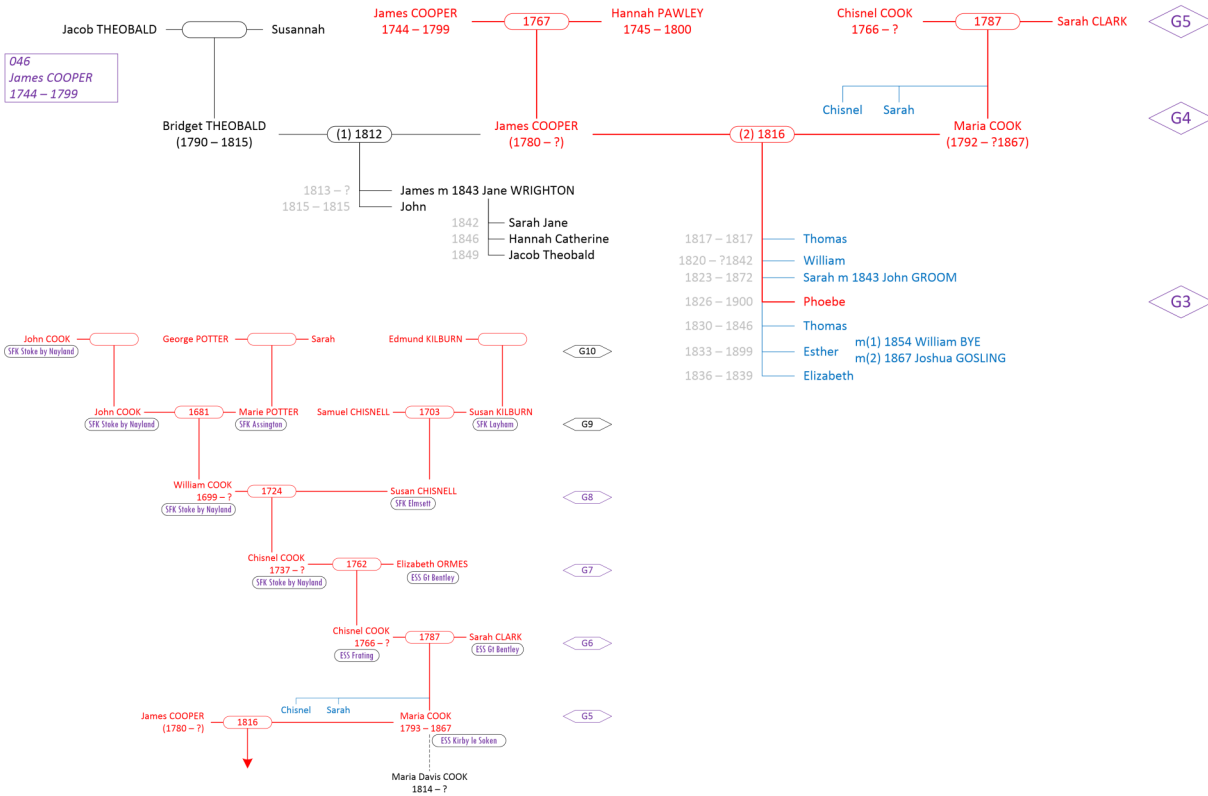

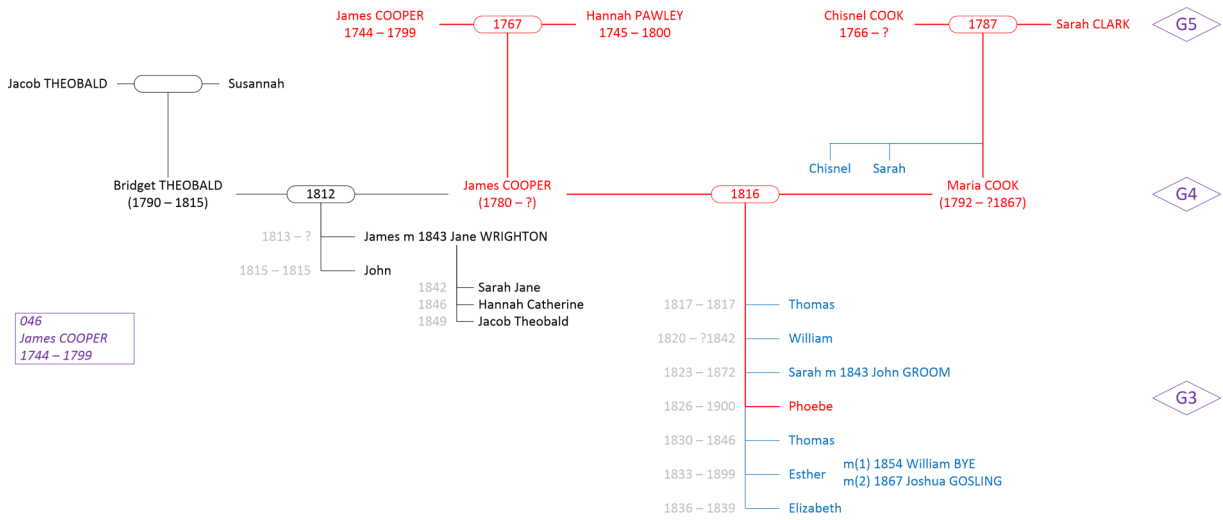

O46  
 James COOPER  
 1744 – 1799

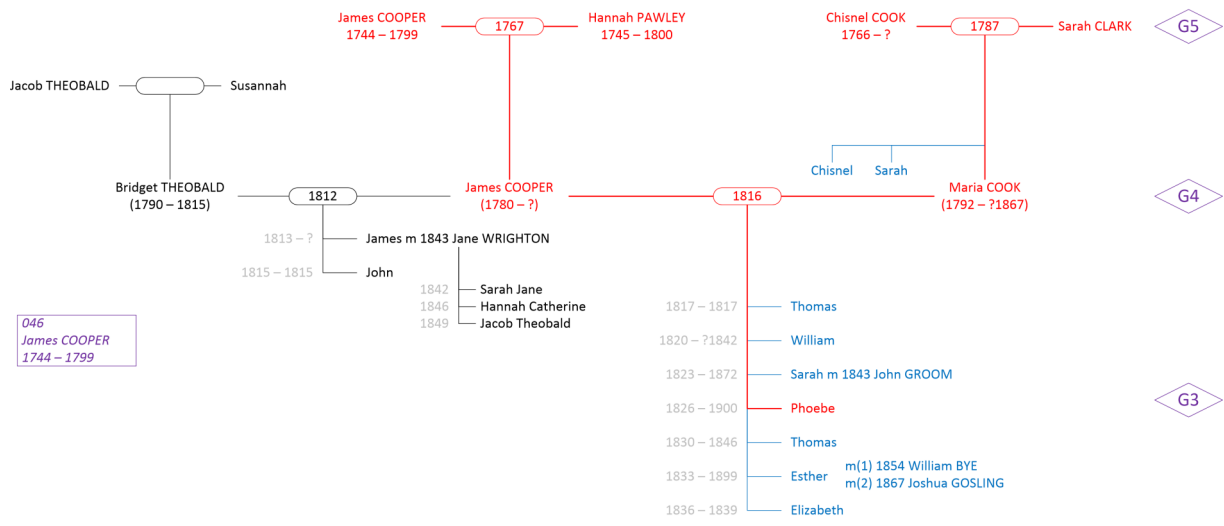



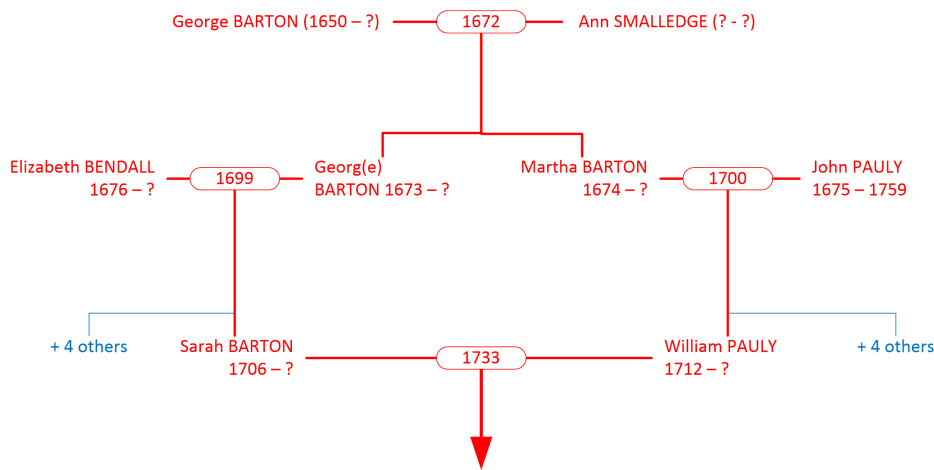

G9

G8

G7

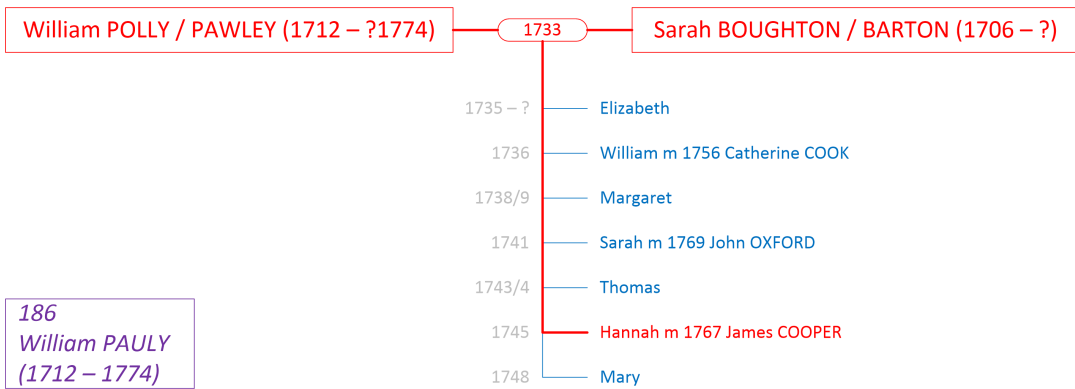

186  
William PAULY  
(1712 - 1774)

G7

G6



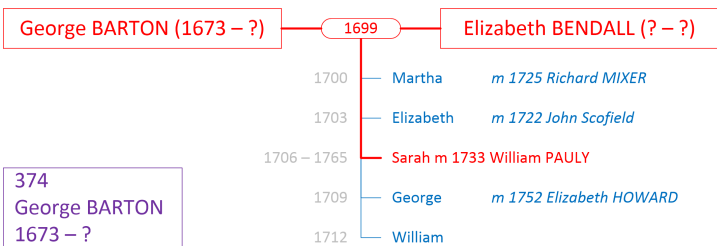
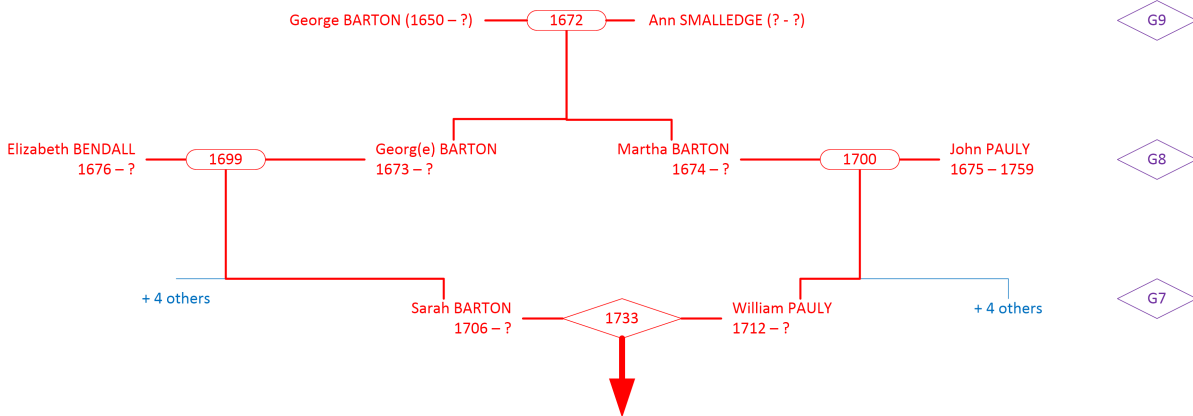
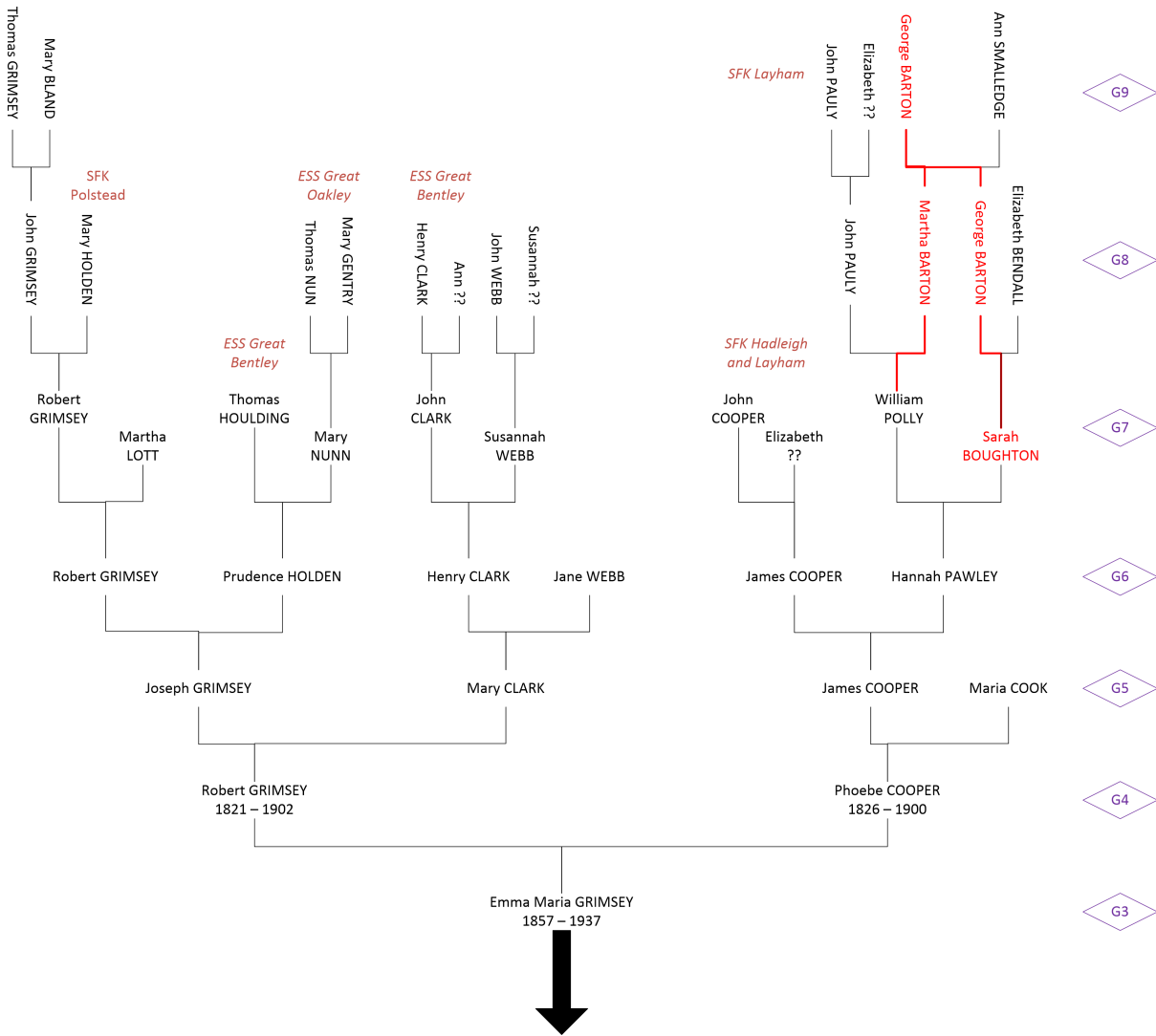

374  
George BARTON  
1673 - ?

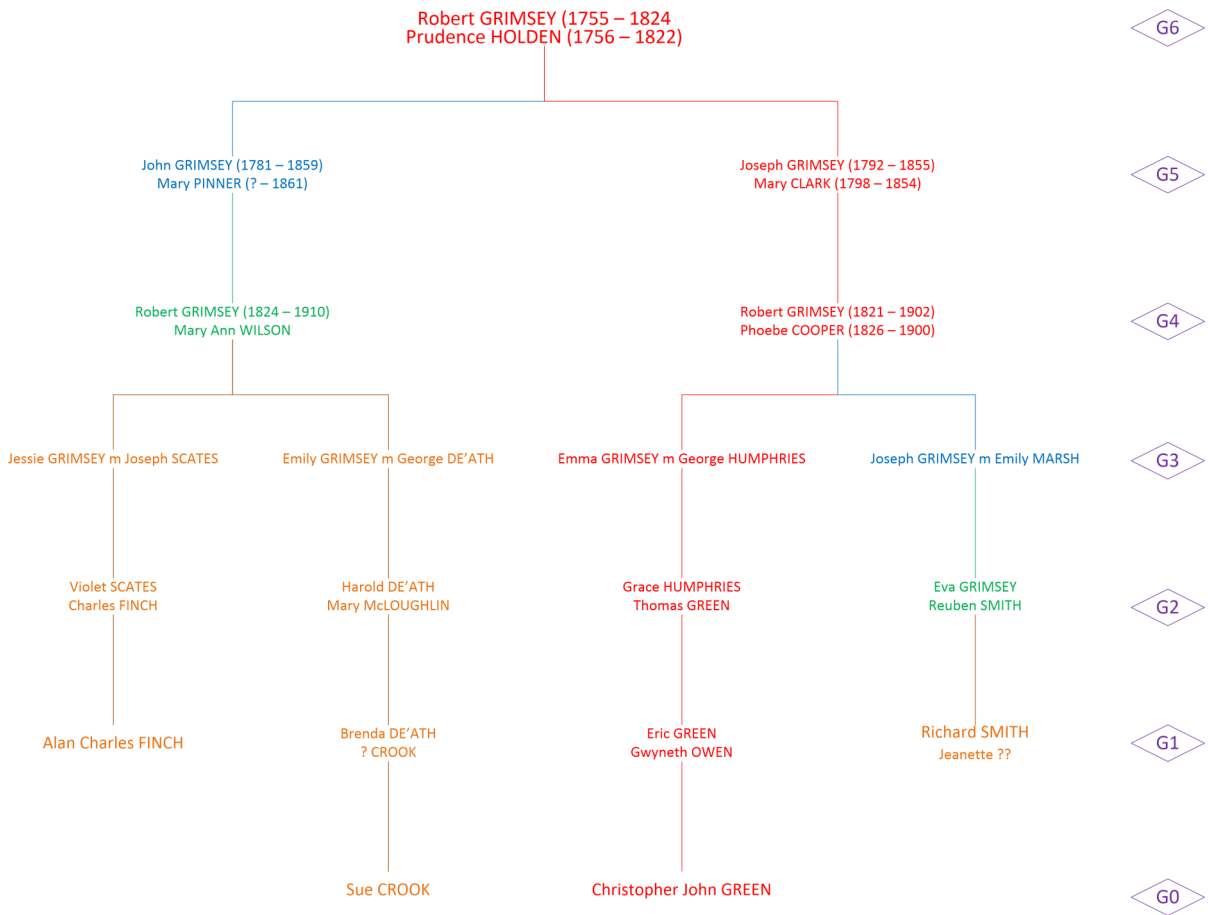

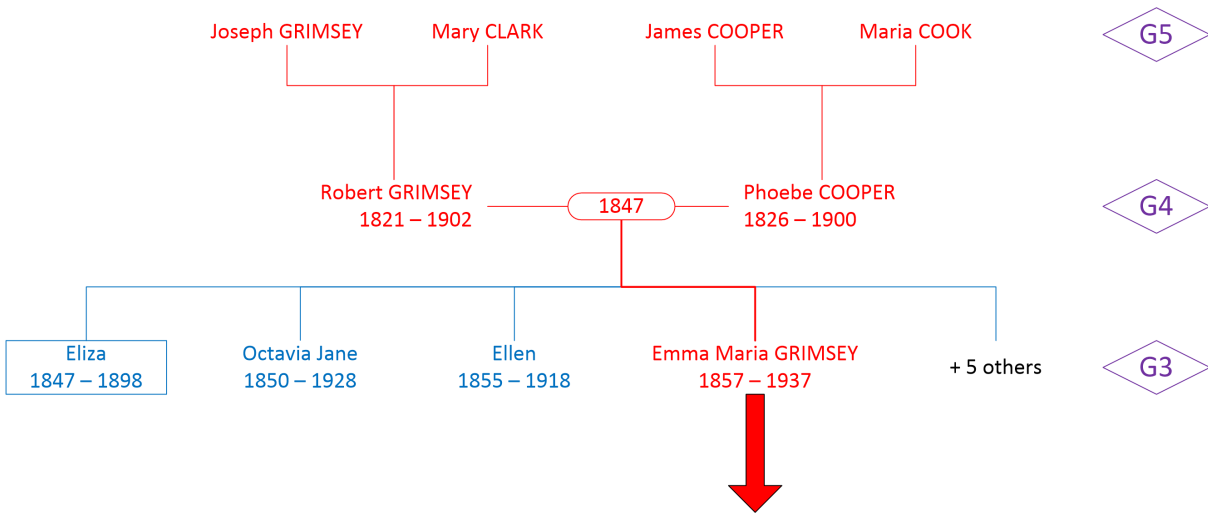

Eliza GRIMSEY (1847 – 1898) m 1869 Thomas Henry ELLIS (1845 – 1908)

*011K*  
*Eliza GRIMSEY*  
*1847 – 1898*

- 1870 — Mary
- 1875 — Florence
- 1879 — Richard m Emilie ??

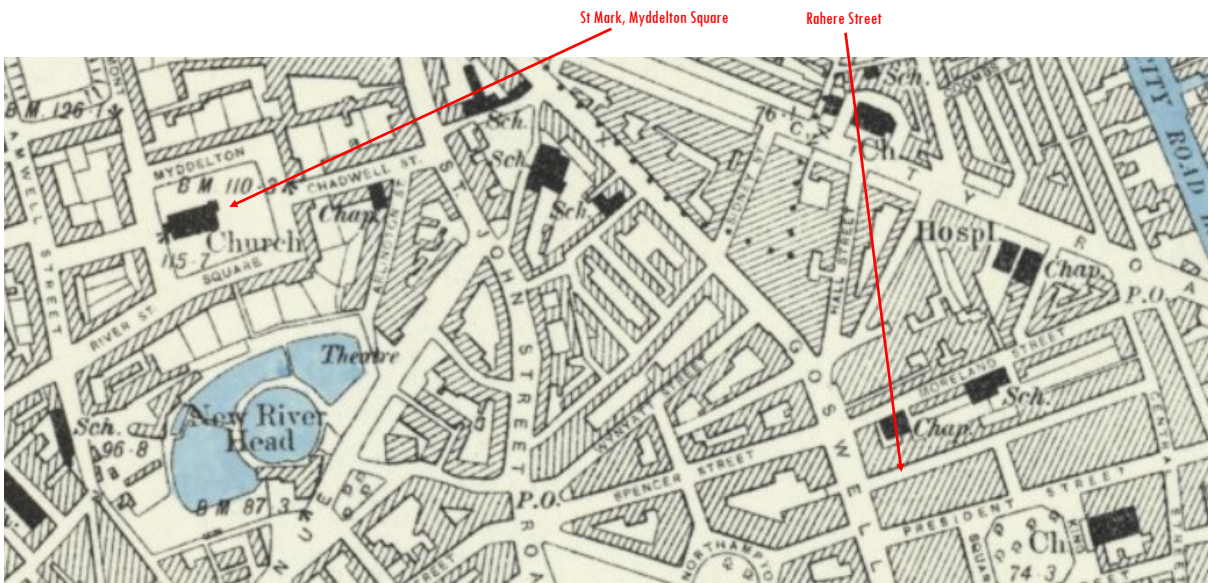

Eliza GRIMSEY (1847 – 1898) m 1869 Thomas Henry ELLIS (1845 – 1908)

*011K*  
*Eliza GRIMSEY*  
*1847 – 1898*

1870 — Mary  
1875 — Florence  
1879 — Richard m Emilie ??



Octavia Jane GRIMSEY (1850 –1928) m 1873 Stephen CAREY (1852 – 1933)

*011L*

*Octavia Jane GRIMSEY  
1850 – 1928*

1874 – 1932	—	Alfred <i>emigrated to Canada</i>
1877 – 1946	—	Frank m 1903 Maud BROWN
1883 – 1967	—	George m 1912 Amy WHENT
1886 – 1970	—	Arthur m 1909 Ada SMITH
1888 – 1899	—	Nellie
1890 – 1937	—	Louisa m 1907 Charles REASON
1893 – 1920	—	Ethel m 1917 Arthur BAILEY

Octavia Jane GRIMSEY (1850 –1928) m 1873 Stephen CAREY (1852 – 1933)

*O11L*  
*Octavia Jane GRIMSEY*  
*1850 – 1928*

- 1874 – 1932 — Alfred *emigrated to Canada*
- 1877 – 1946 — Frank m 1903 Maud BROWN
- 1883 – 1967 — George m 1912 Amy WHENT
- 1886 – 1970 — Arthur m 1909 Ada SMITH
- 1888 – 1899 — Nellie
- 1890 – 1937 — Louisa m 1907 Charles REASON
- 1893 – 1920 — Ethel m 1917 Arthur BAILEY

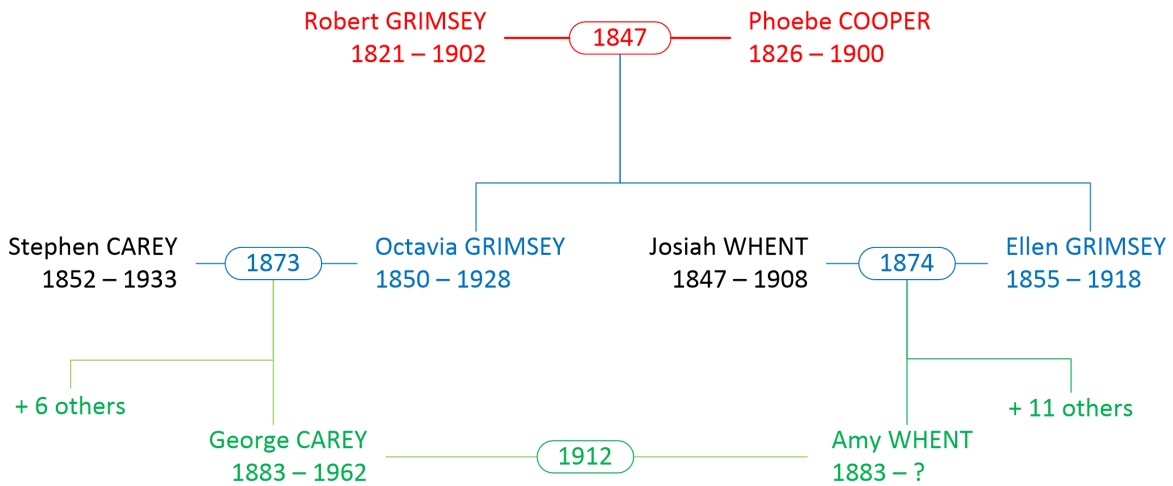

Octavia Jane GRIMSEY (1850 –1928) m 1873 Stephen CAREY (1852 – 1933)

*011L*

*Octavia Jane GRIMSEY  
1850 – 1928*

1874 – 1932	—	Alfred <i>emigrated to Canada</i>
1877 – 1946	—	Frank m 1903 Maud BROWN
1883 – 1967	—	George m 1912 Amy WHENT
1886 – 1970	—	Arthur m 1909 Ada SMITH
1888 – 1899	—	Nellie
1890 – 1937	—	Louisa m 1907 Charles REASON
1893 – 1920	—	Ethel m 1917 Arthur BAILEY



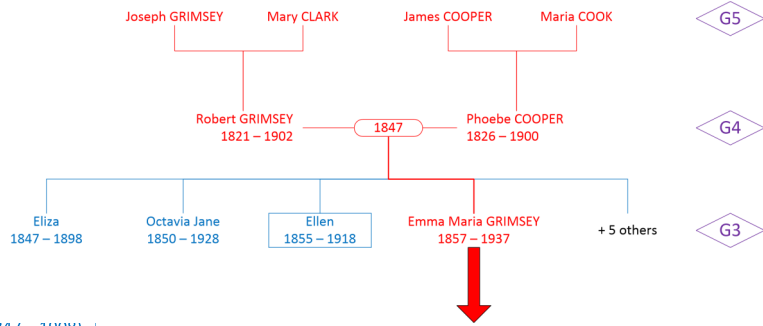

Ellen GRIMSEY (1855 – 1918) m 1874 Josiah WHEAT (184 / – 1908)

- 1875 – 1962 — Alice m 1904 Charles BUTLER – (at least) 3 sons
- 1877 – 1878 — Daisy
- 1877 – 1957 — Emma
- 1879 – 1940 — Minnie
- 1881 – 1953 — Annie Ada m 1909
- 1883 – 1962 — Amy m 1912 George CAREY
- 1885 – 1964 — Lillie Louise m 1912 Victor CAZALEY – 1 dau, 1 da
- 1887 – ? — Ethel Kate m (1) 1916 Henry WILKINSON  
m (2) Harry ANDREWS – 1 son, 1 dau
- 1889 – 1975 — Hester Hilda m 1916 Alfred BAKER
- 1892 – 1975 — James Josiah Arthur m 1914 Dorothy WEST – 2 children
- 1896 – 1963 — Robert Joseph m 1915 Minnie REED – 2 children
- 1899 – 1971 — Clara Ruth m 1942 Harry SIEBER

*011M*  
Ellen GRIMSEY  
1855 – 1918

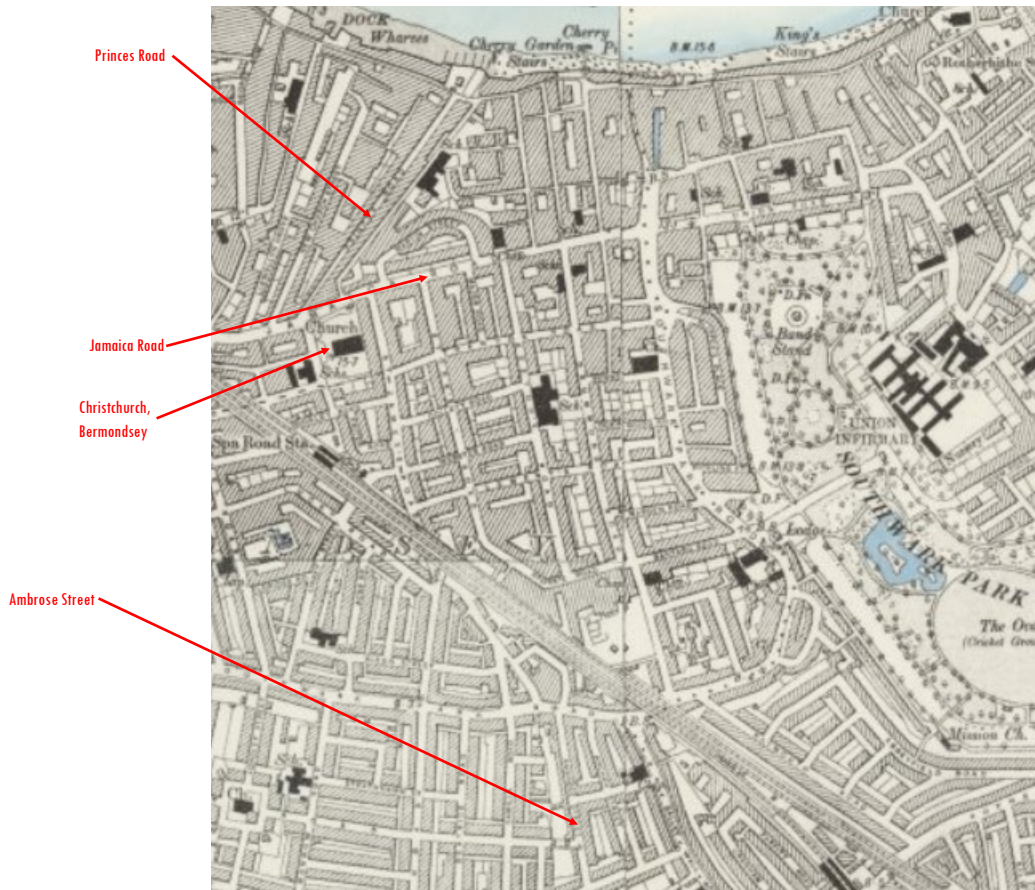

Ellen GRIMSEY (1855 – 1918) m 1874 Josiah WHENT (1847 – 1908)

- 1875 – 1962 — Alice m 1904 Charles BUTLER – *(at least) 3 sons*
- 1877 – 1878 — Daisy
- 1877 – 1957 — Emma
- 1879 – 1940 — Minnie
- 1881 – 1953 — Annie Ada m 1909
- 1883 – 1962 — Amy m 1912 George CAREY
- 1885 – 1964 — Lillie Louise m 1912 Victor CAZALEY – *1 dau, Ida*
- 1887 – ? — Ethel Kate m (1) 1916 Henry WILKINSON  
m (2) Harry ANDREWS – *1 son, 1 dau*
- 1889 – 1975 — Hester Hilda m 1916 Alfred BAKER
- 1892 – 1975 — James Josiah Arthur m 1914 Dorothy WEST – *2 children*
- 1896 – 1963 — Robert Joseph m 1915 Minnie REED – *2 children*
- 1899 – 1971 — Clara Ruth m 1942 Harry SIEBER

**011M**  
**Ellen GRIMSEY**  
**1855 – 1918**

Ellen GRIMSEY (1855 – 1918) m 1874 Josiah WHENT (1847 – 1908)

- 1875 – 1962 — Alice m 1904 Charles BUTLER – *(at least) 3 sons*
- 1877 – 1878 — Daisy
- 1877 – 1957 — Emma
- 1879 – 1940 — Minnie
- 1881 – 1953 — Annie Ada m 1909
- 1883 – 1962 — Amy m 1912 George CAREY
- 1885 – 1964 — Lillie Louise m 1912 Victor CAZALEY – *1 dau, Ida*
- 1887 – ? — Ethel Kate m (1) 1916 Henry WILKINSON  
m (2) Harry ANDREWS – *1 son, 1 dau*
- 1889 – 1975 — Hester Hilda m 1916 Alfred BAKER
- 1892 – 1975 — James Josiah Arthur m 1914 Dorothy WEST – *2 children*
- 1896 – 1963 — Robert Joseph m 1915 Minnie REED – *2 children*
- 1899 – 1971 — Clara Ruth m 1942 Harry SIEBER

**011M**  
**Ellen GRIMSEY**  
**1855 – 1918**

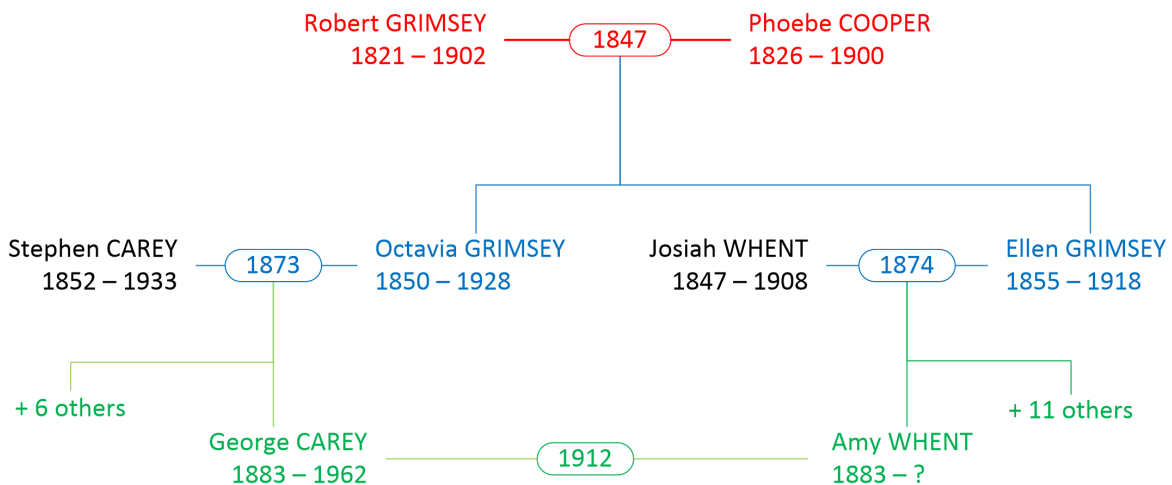

Ellen GRIMSEY (1855 – 1918) m 1874 Josiah WHENT (1847 – 1908)

- 1875 – 1962 — Alice m 1904 Charles BUTLER – *(at least) 3 sons*
- 1877 – 1878 — Daisy
- 1877 – 1957 — Emma
- 1879 – 1940 — Minnie
- 1881 – 1953 — Annie Ada m 1909
- 1883 – 1962 — Amy m 1912 George CAREY
- 1885 – 1964 — Lillie Louise m 1912 Victor CAZALEY – *1 dau, 1 da*
- 1887 – ? — Ethel Kate m (1) 1916 Henry WILKINSON  
m (2) Harry ANDREWS – *1 son, 1 dau*
- 1889 – 1975 — Hester Hilda m 1916 Alfred BAKER
- 1892 – 1975 — James Josiah Arthur m 1914 Dorothy WEST – *2 children*
- 1896 – 1963 — Robert Joseph m 1915 Minnie REED – *2 children*
- 1899 – 1971 — Clara Ruth m 1942 Harry SIEBER

*011M*  
*Ellen GRIMSEY*  
*1855 – 1918*

Ellen GRIMSEY (1855 – 1918) m 1874 Josiah WHENT (1847 – 1908)

- 1875 – 1962 — Alice m 1904 Charles BUTLER – *(at least) 3 sons*
- 1877 – 1878 — Daisy
- 1877 – 1957 — Emma
- 1879 – 1940 — Minnie
- 1881 – 1953 — Annie Ada m 1909
- 1883 – 1962 — Amy m 1912 George CAREY
- 1885 – 1964 — Lillie Louise m 1912 Victor CAZALEY – *1 dau, Ida*
- 1887 – ? — Ethel Kate m (1) 1916 Henry WILKINSON  
m (2) Harry ANDREWS – *1 son, 1 dau*
- 1889 – 1975 — Hester Hilda m 1916 Alfred BAKER
- 1892 – 1975 — James Josiah Arthur m 1914 Dorothy WEST – *2 children*
- 1896 – 1963 — Robert Joseph m 1915 Minnie REED – *2 children*
- 1899 – 1971 — Clara Ruth m 1942 Harry SIEBER

**011M**  
**Ellen GRIMSEY**  
**1855 – 1918**

Ellen GRIMSEY (1855 – 1918) m 1874 Josiah WHENT (1847 – 1908)

- 1875 – 1962 — Alice m 1904 Charles BUTLER – *(at least) 3 sons*
- 1877 – 1878 — Daisy
- 1877 – 1957 — Emma
- 1879 – 1940 — Minnie
- 1881 – 1953 — Annie Ada m 1909
- 1883 – 1962 — Amy m 1912 George CAREY
- 1885 – 1964 — Lillie Louise m 1912 Victor CAZALEY – *1 dau, Ida*
- 1887 – ? — Ethel Kate m (1) 1916 Henry WILKINSON  
m (2) Harry ANDREWS – *1 son, 1 dau*
- 1889 – 1975 — Hester Hilda m 1916 Alfred BAKER
- 1892 – 1975 — James Josiah Arthur m 1914 Dorothy WEST – *2 children*
- 1896 – 1963 — Robert Joseph m 1915 Minnie REED – *2 children*
- 1899 – 1971 — Clara Ruth m 1942 Harry SIEBER

*011M*  
*Ellen GRIMSEY*  
*1855 – 1918*

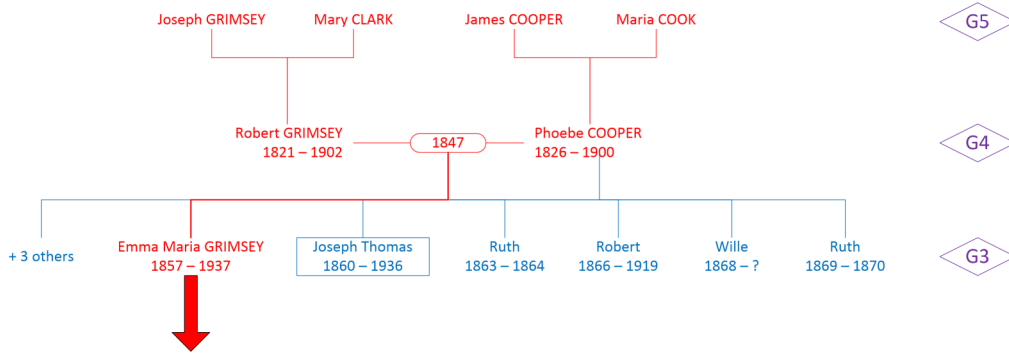

Joseph Thomas GRIMSEY (1860 – 1936) m 1881 Emily MARSH (1860 – 1953)

- 1882 – 1959 — William Thomas
- 1885 – 1969 — Arthur m 1921 Laura THROWER – 2 children
- 1887 – 1951 — Mabel Emily m 1932 George William (Bill) MILES
- 1889 – 1961 — Lily Alice m 1914 Major NELSON – 5 children
- 1892 – 1918 — Joseph
- 1894 – 1983 — Edith Mary m 1921 Percy GASSON – 2 children
- 1897 – 1983 — Eva May m 1925 Reuben SMITH – 4 children
- 1900 – 1974 — Olive Maud m (1) 1938 William GORMAN m (2) 1951 David BECK
- 1902 – 1932 — Alfred Charles

*011N*  
*Joseph Thomas GRIMSEY*  
*1860 – 1936*

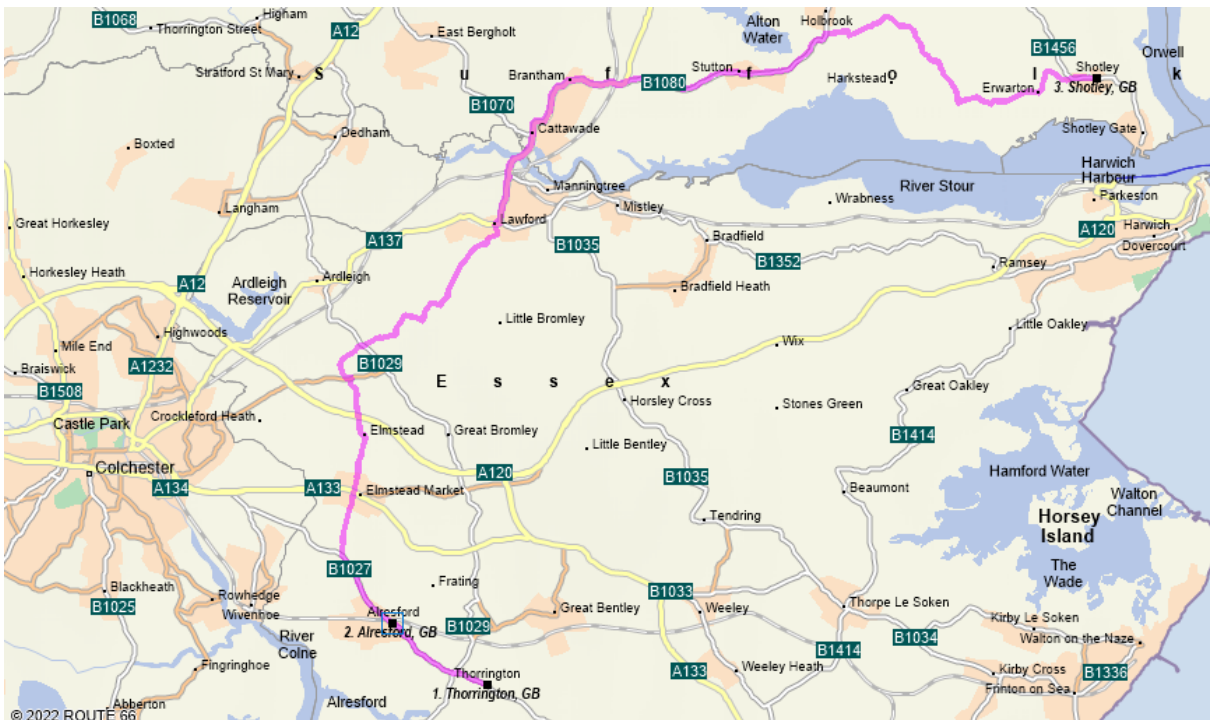

Joseph Thomas GRIMSEY (1860 – 1936) m 1881 Emily MARSH (1860 – 1953)

- 1882 – 1959 — William Thomas
- 1885 – 1969 — Arthur m 1921 Laura THROWER – 2 children
- 1887 – 1951 — Mabel Emily m 1932 George William (Bill) MILES
- 1889 – 1961 — Lily Alice m 1914 Major NELSON – 5 children
- 1892 – 1918 — Joseph
- 1894 – 1983 — Edith Mary m 1921 Percy GASSON – 2 children
- 1897 – 1983 — Eva May m 1925 Reuben SMITH – 4 children
- 1900 – 1974 — Olive Maud m (1) 1938 William GORMAN  
m (2) 1951 David BECK
- 1902 – 1932 — Alfred Charles

**011N**  
**Joseph Thomas GRIMSEY**  
**1860 – 1936**



Joseph Thomas GRIMSEY (1860 – 1936) m 1881 Emily MARSH (1860 – 1953)

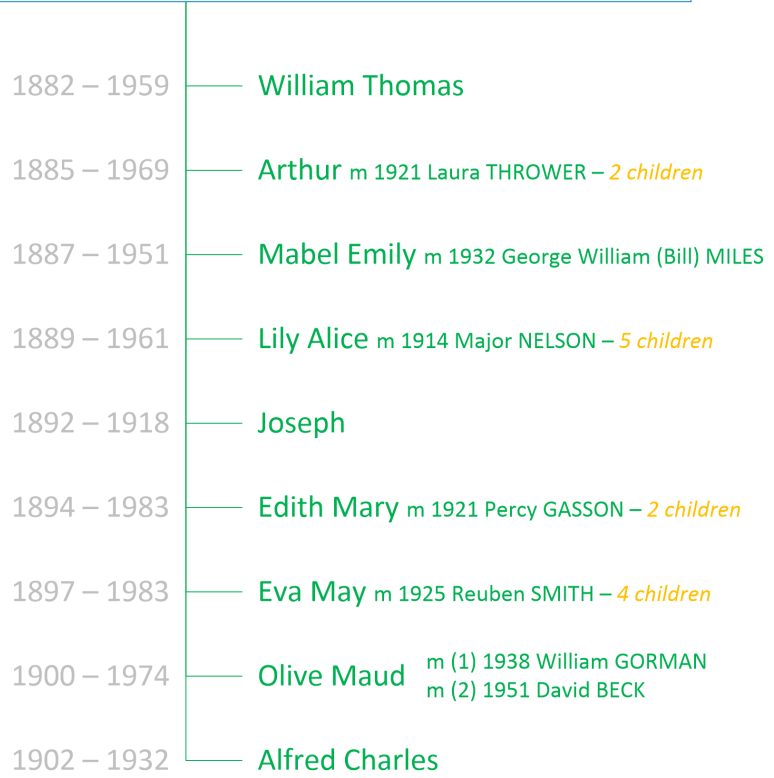

**011N**  
**Joseph Thomas GRIMSEY**  
**1860 – 1936**

Joseph Thomas GRIMSEY (1860 – 1936) m 1881 Emily MARSH (1860 – 1953)

- 1882 – 1959 — William Thomas
- 1885 – 1969 — Arthur m 1921 Laura THROWER – 2 children
- 1887 – 1951 — Mabel Emily m 1932 George William (Bill) MILES
- 1889 – 1961 — Lily Alice m 1914 Major NELSON – 5 children
- 1892 – 1918 — Joseph
- 1894 – 1983 — Edith Mary m 1921 Percy GASSON – 2 children
- 1897 – 1983 — Eva May m 1925 Reuben SMITH – 4 children
- 1900 – 1974 — Olive Maud m (1) 1938 William GORMAN  
m (2) 1951 David BECK
- 1902 – 1932 — Alfred Charles

**011N**  
**Joseph Thomas GRIMSEY**  
**1860 – 1936**

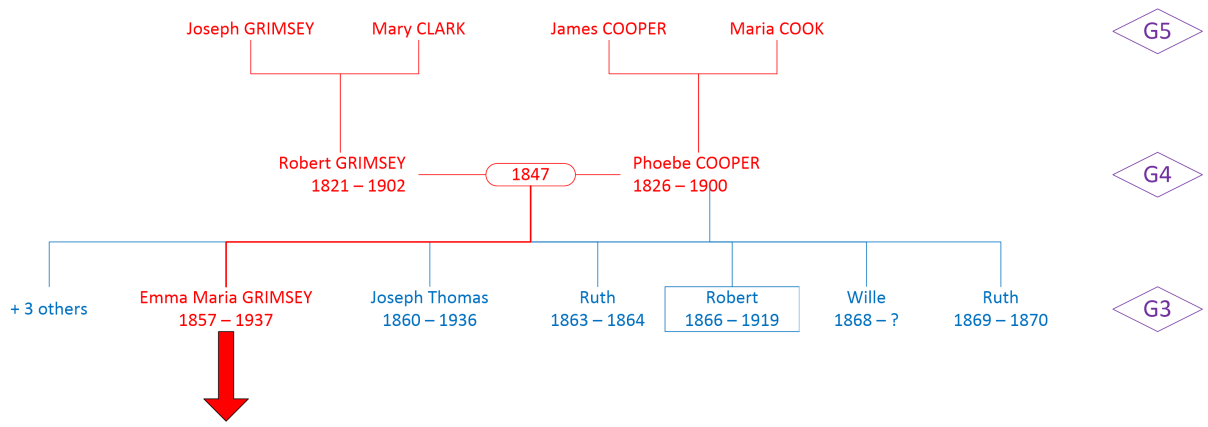

011P  
Robert GRIMSEY  
1866 – 1919

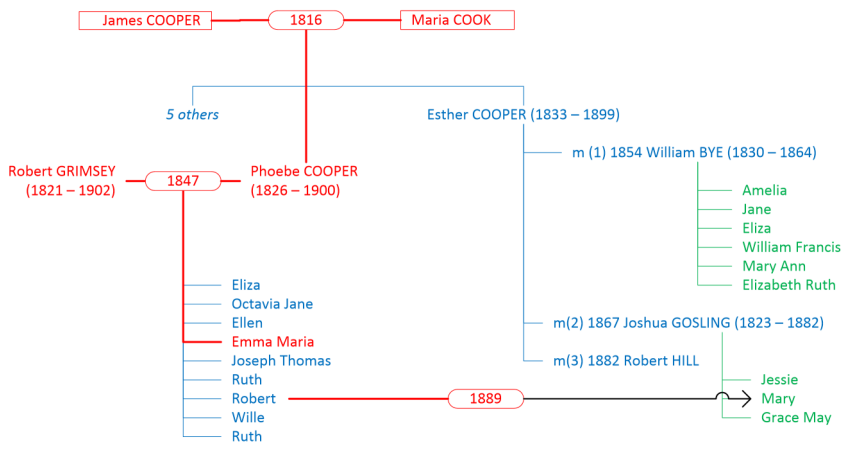
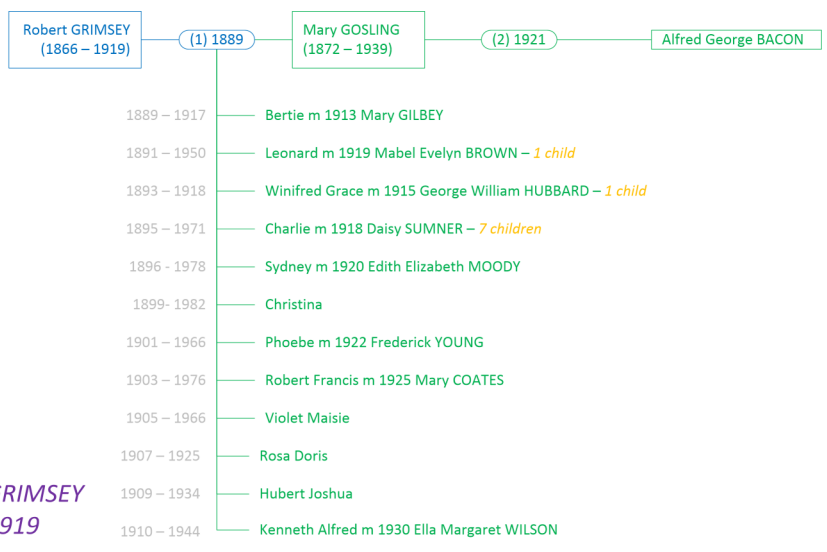

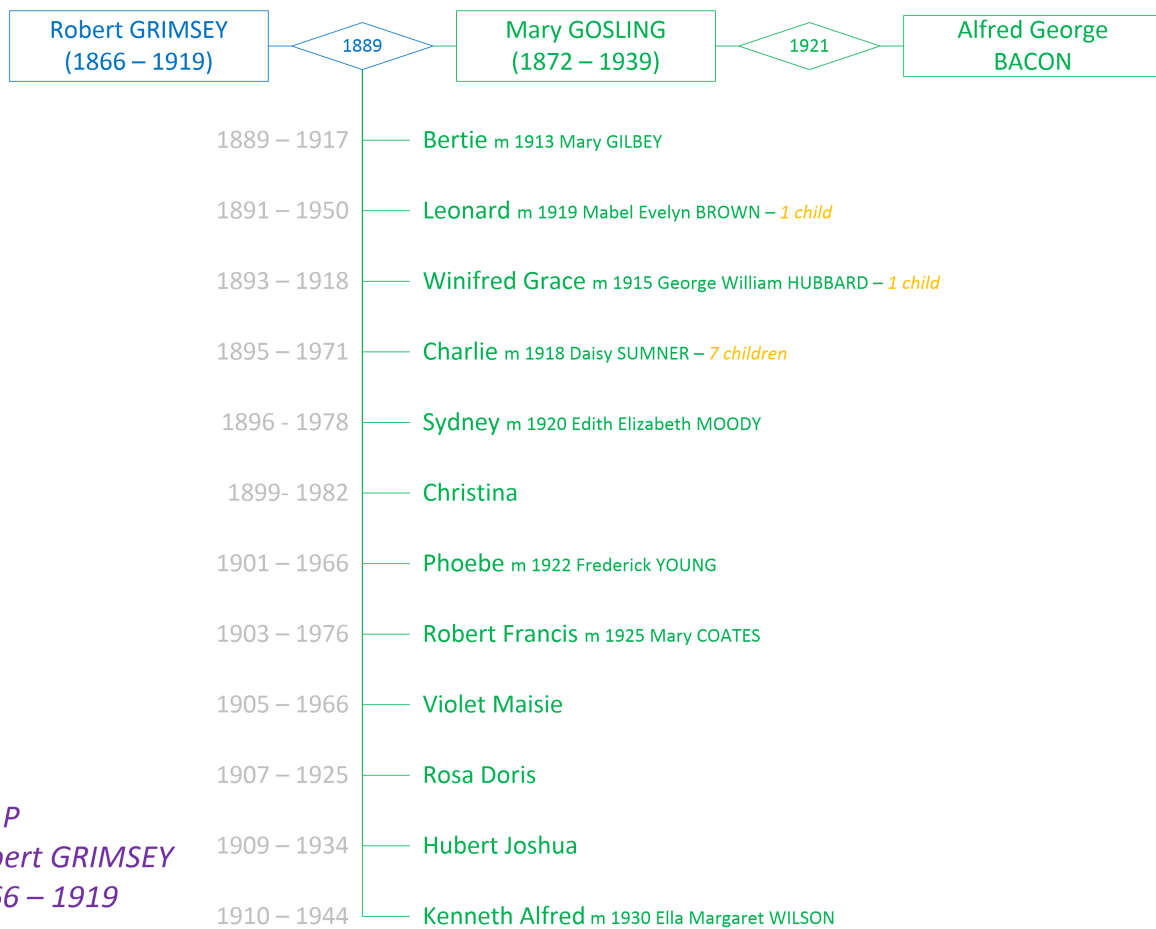

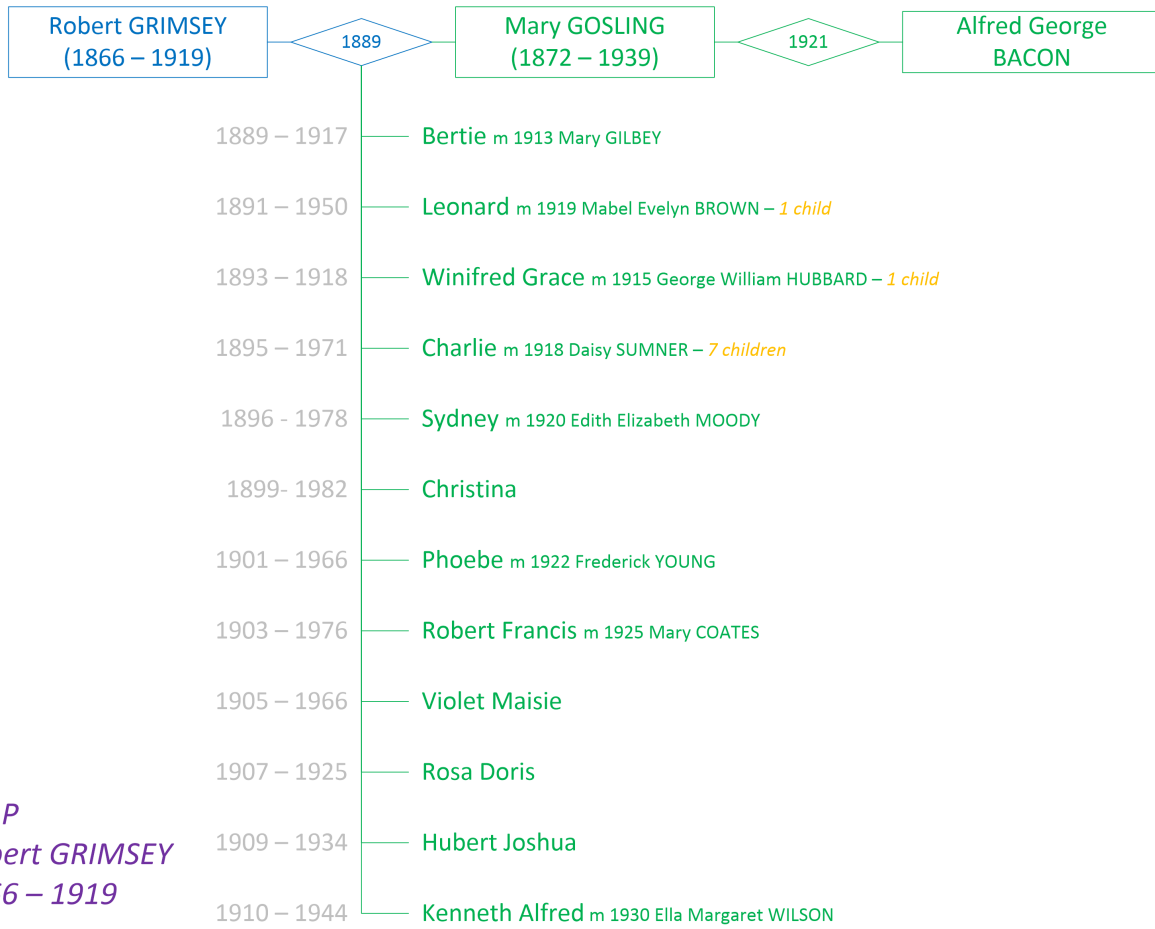

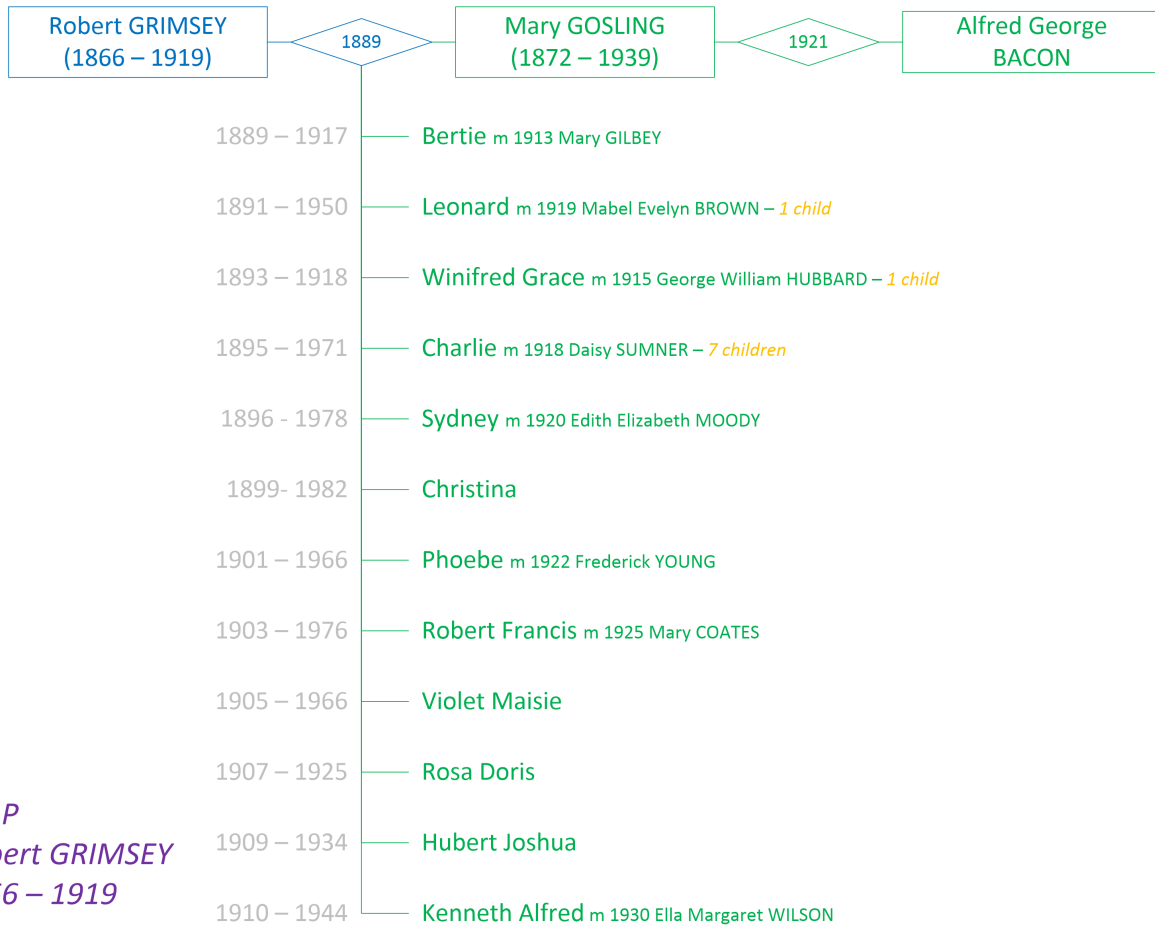

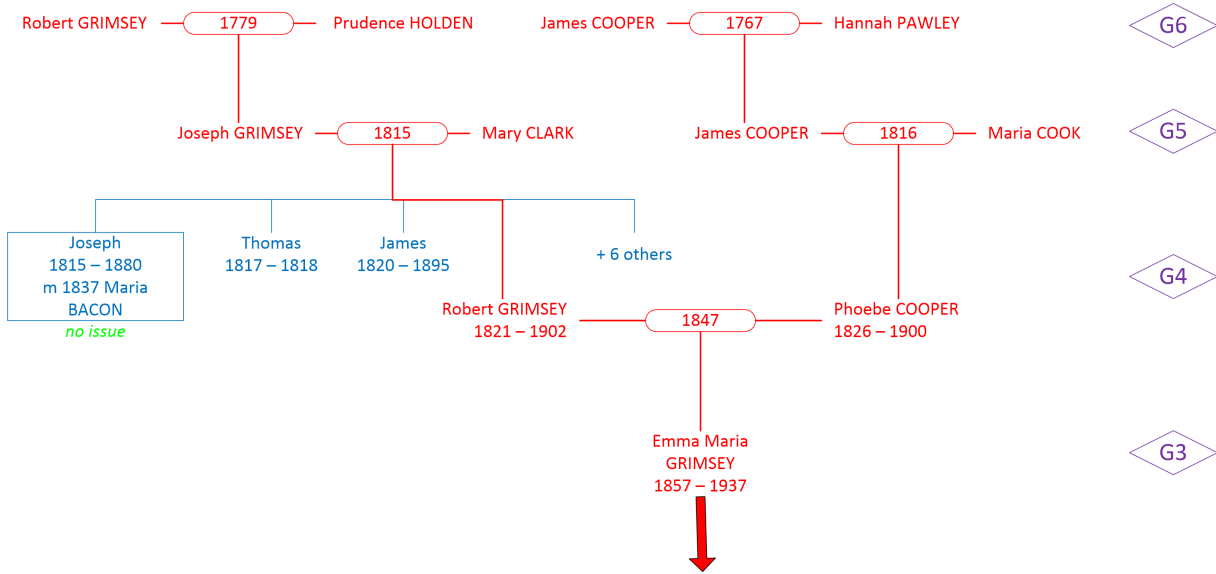

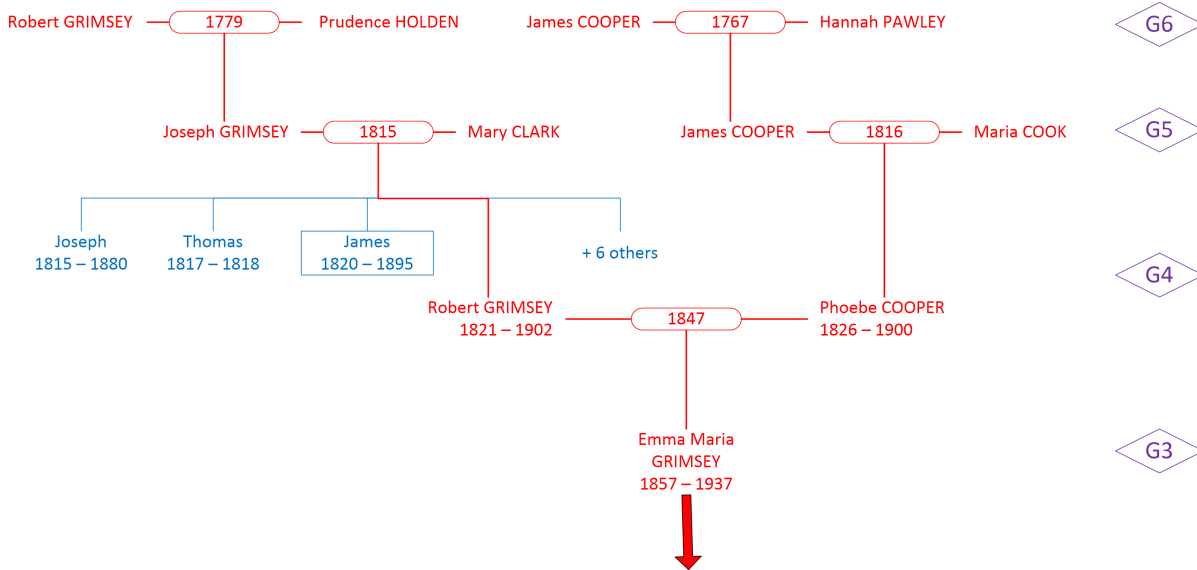

James GRIMSEY (1820 – 1895) m 1846 Caroline GILDERS (1823 – 1909)

*022M*  
*James GRIMSEY*  
*1820 – 1895*

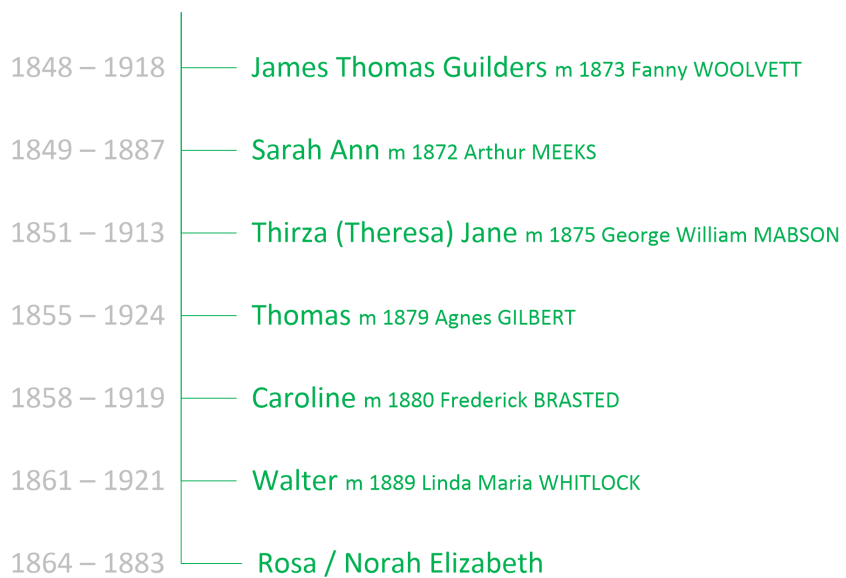



James GRIMSEY (1820 – 1895) m 1846 Caroline GILDERS (1823 – 1909)

1848 – 1918 — James Thomas Guilders m 1873 Fanny WOOLVETT  
1849 – 1887 — Sarah Ann m 1872 Arthur MEEKS  
1851 – 1913 — Thirza (Theresa) Jane m 1875 George William MABSON  
1855 – 1924 — Thomas m 1879 Agnes GILBERT  
1858 – 1919 — Caroline m 1880 Frederick BRASTED  
1861 – 1921 — Walter m 1889 Linda Maria WHITLOCK  
1864 – 1883 — Rosa / Norah Elizabeth

*022M*  
*James GRIMSEY*  
*1820 – 1895*

James GRIMSEY (1820 – 1895) m 1846 Caroline GILDERS (1823 – 1909)

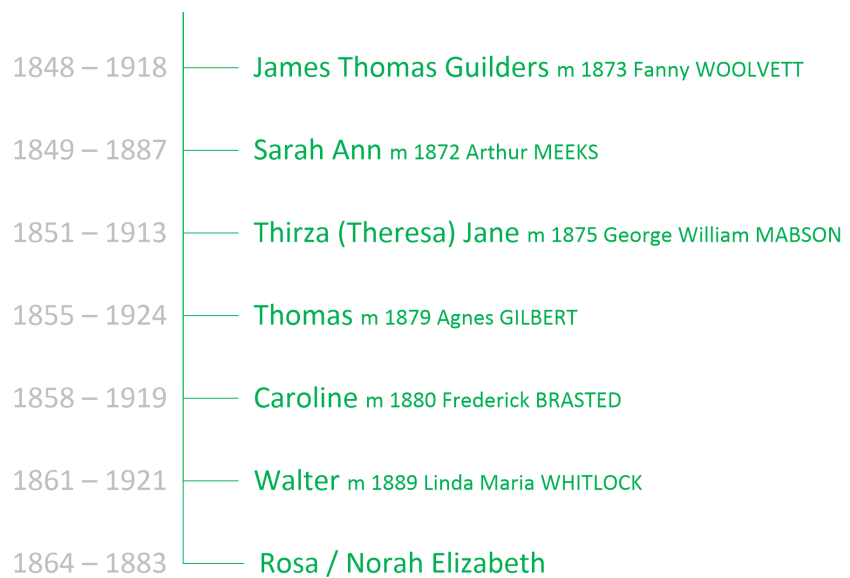

*022M*  
*James GRIMSEY*  
*1820 – 1895*

James GRIMSEY (1820 – 1895) m 1846 Caroline GILDERS (1823 – 1909)

1848 – 1918 — James Thomas Guilders m 1873 Fanny WOOLVETT  
1849 – 1887 — Sarah Ann m 1872 Arthur MEEKS  
1851 – 1913 — Thirza (Theresa) Jane m 1875 George William MABSON  
1855 – 1924 — Thomas m 1879 Agnes GILBERT  
1858 – 1919 — Caroline m 1880 Frederick BRASTED  
1861 – 1921 — Walter m 1889 Linda Maria WHITLOCK  
1864 – 1883 — Rosa / Norah Elizabeth

*022M*  
*James GRIMSEY*  
*1820 – 1895*

James GRIMSEY (1820 – 1895) m 1846 Caroline GILDERS (1823 – 1909)

1848 – 1918 — James Thomas Guilders m 1873 Fanny WOOLVETT  
1849 – 1887 — Sarah Ann m 1872 Arthur MEEKS  
1851 – 1913 — Thirza (Theresa) Jane m 1875 George William MABSON  
1855 – 1924 — Thomas m 1879 Agnes GILBERT  
1858 – 1919 — Caroline m 1880 Frederick BRASTED  
1861 – 1921 — Walter m 1889 Linda Maria WHITLOCK  
1864 – 1883 — Rosa / Norah Elizabeth

*022M*  
*James GRIMSEY*  
*1820 – 1895*

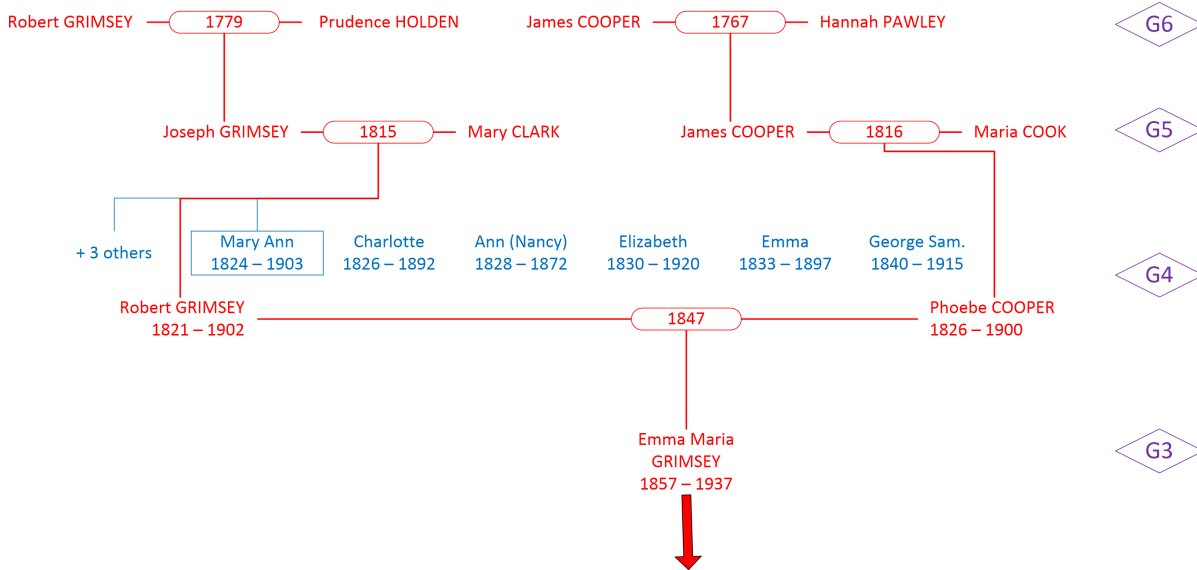

Joseph ROSE (1818 – 1889) m 1843 Mary Ann GRIMSEY (1824 – 1903)

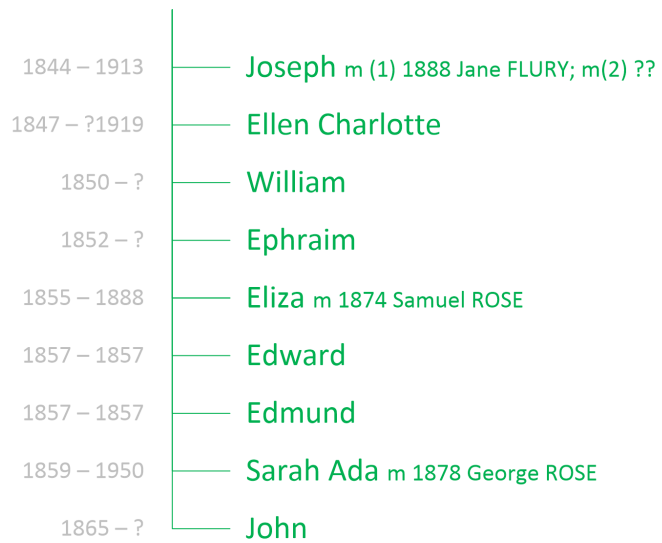

022N  
 Mary Ann GRIMSEY  
 1824 – 1903

Joseph ROSE (1818 – 1889) m 1843 Mary Ann GRIMSEY (1824 – 1903)

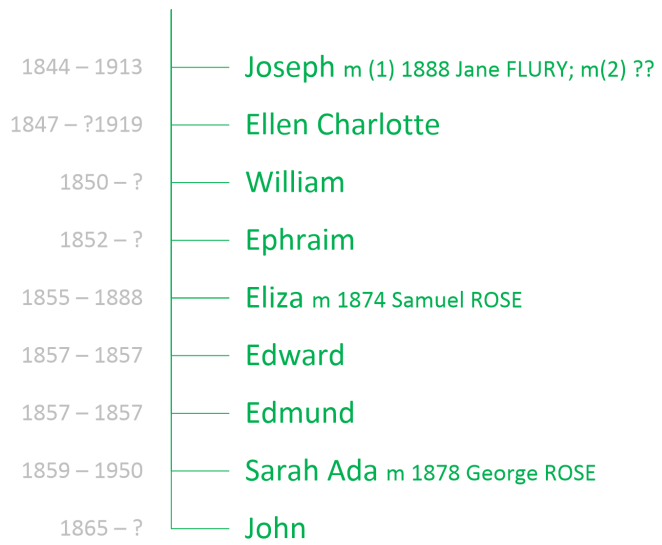

022N  
Mary Ann GRIMSEY  
1824 – 1903

Joseph ROSE (1818 – 1889) m 1843 Mary Ann GRIMSEY (1824 – 1903)

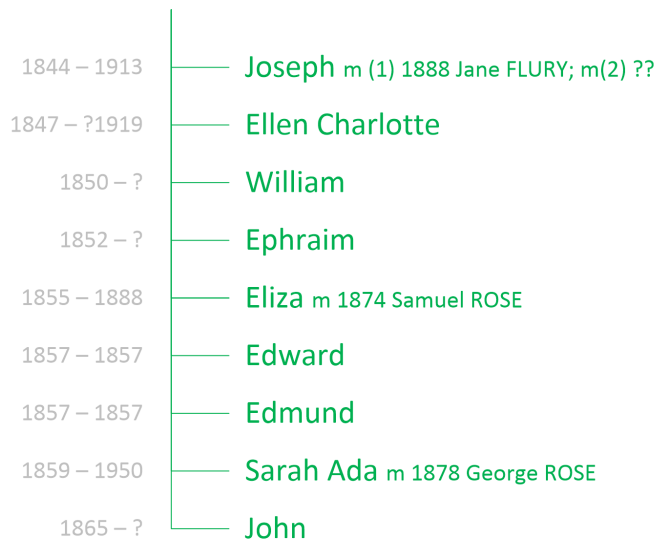

022N  
Mary Ann GRIMSEY  
1824 – 1903

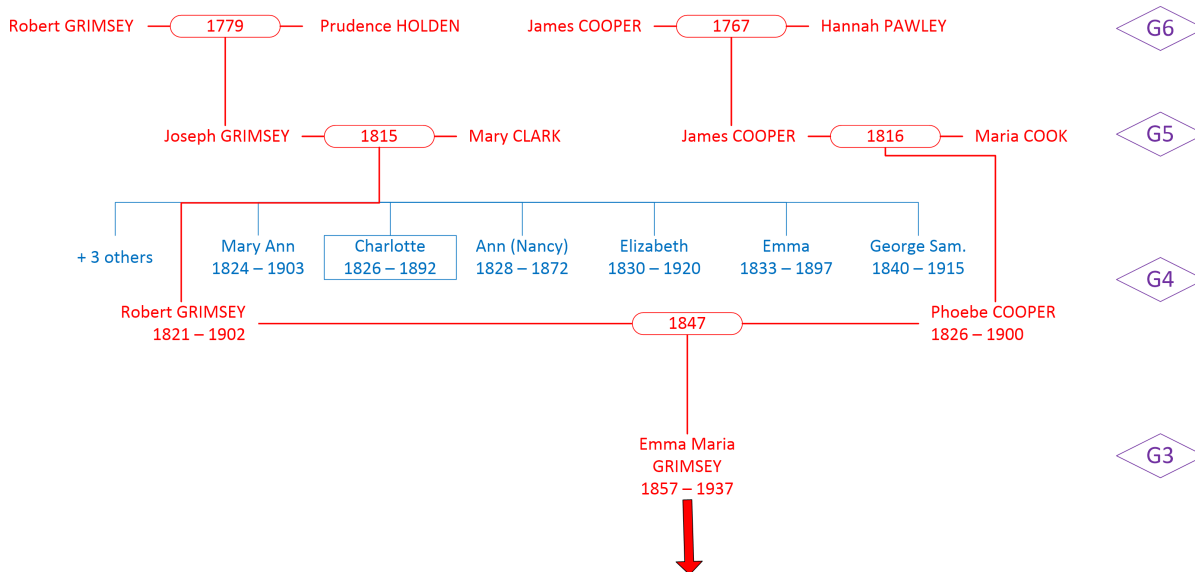

William ANNIS (1824 – 1903) m 1848 Charlotte GRIMSEY (1826 – 1892)

- 1850 – 1912 — Charlotte Elizabeth m 1873 William TOWNSEND
- 1852 – 1931 — Bethia m 1876 John Frederick Vincent KING — 10 children
- 1853 – 1939 — William John
- 1856 – 1857 — Ellen Alma
- 1858 – 1926 — (Ellen) Alma m 1878 Edgar BURTON — 10 children
- 1860 – 1936 — Amy m 1883 William GILBERT — 8 children
- 1868 – 1956 — James Herbert m 1890 Ada AUSTIN — 4 children
- 1869 – ? — Lily

0220  
Charlotte GRIMSEY  
1826 – 1892



William ANNIS (1824 – 1903) m 1848 Charlotte GRIMSEY (1826 – 1892)

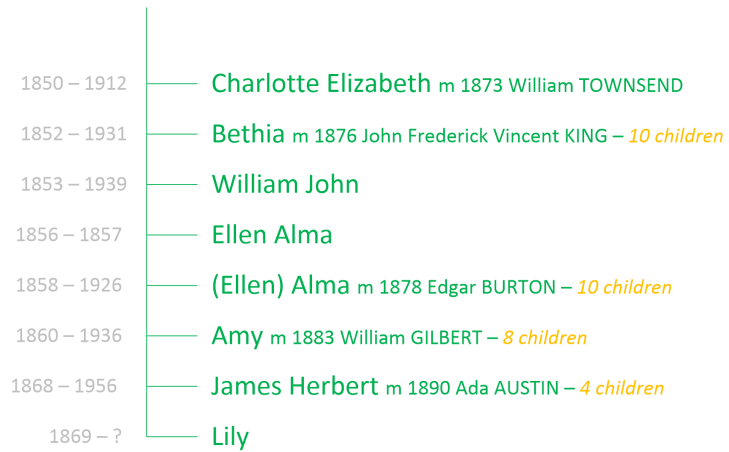

0220  
Charlotte GRIMSEY  
1826 – 1892

John KING (1853 – 1933) m 1878 Bethia ANNIS (1852 – 1931)



0220B  
Bethia ANNIS  
1852 – 1931

William ANNIS (1824 – 1903) m 1848 Charlotte GRIMSEY (1826 – 1892)

0220  
Charlotte GRIMSEY  
1826 – 1892

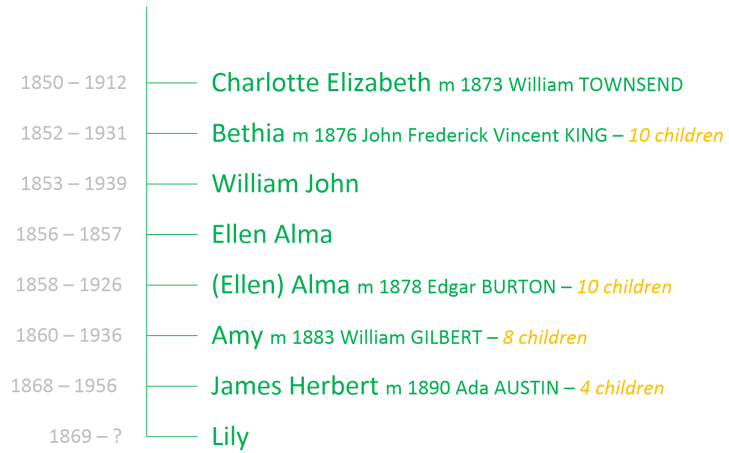

Edgar BURTON (1854 – 1924) m 1878 Ellen Alma ANNIS (1859 – 1926)

Ellen Alma ANNIS  
0220E  
1858 – 1926

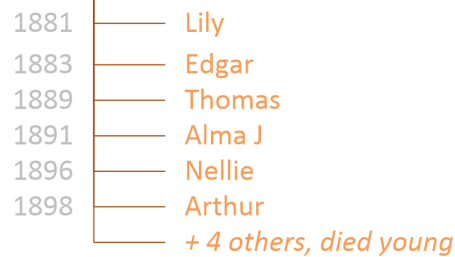

William GILBERT (1854 – 1905) m 1883 Amy ANNIS (1860 – 1936)

0220F  
Amy ANNIS  
1860 – 1936

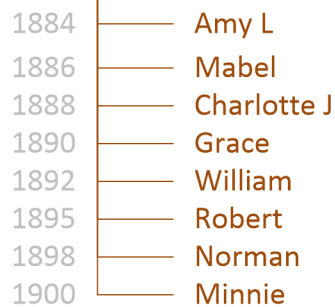

William ANNIS (1824 – 1903) m 1848 Charlotte GRIMSEY (1826 – 1892)

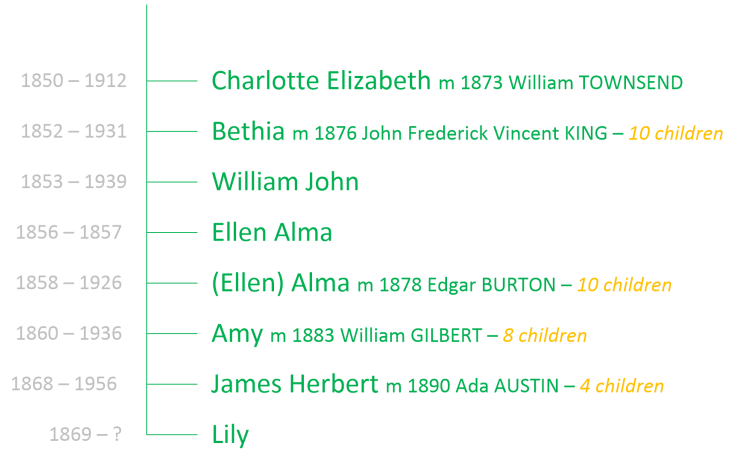

0220  
Charlotte GRIMSEY  
1826 – 1892

James ANNIS (1868 – 1956) m 1883 Ada AUSTIN (1870 – 1944)

0220G  
James ANNIS  
1868 – 1956



Alfred SAVAGE (1873 – 1889) — (1) 1887 — Lily ANNIS (1869 – 1937) — (2) 1890 — Henry WOOD (1870 – ?)



0220H  
Lily ANNIS  
1869 – 1937

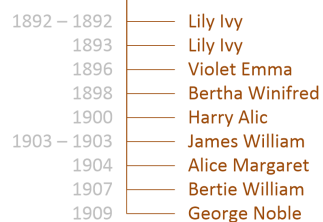

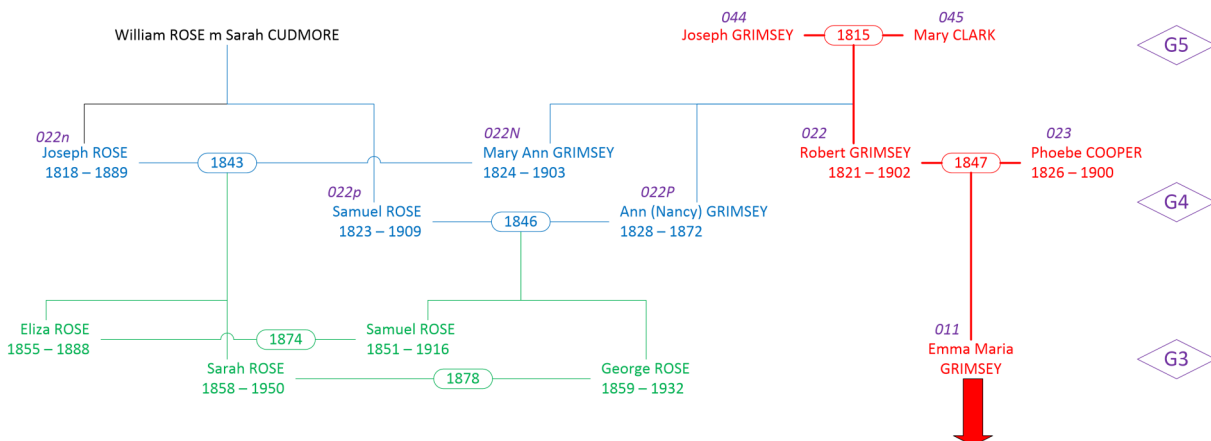
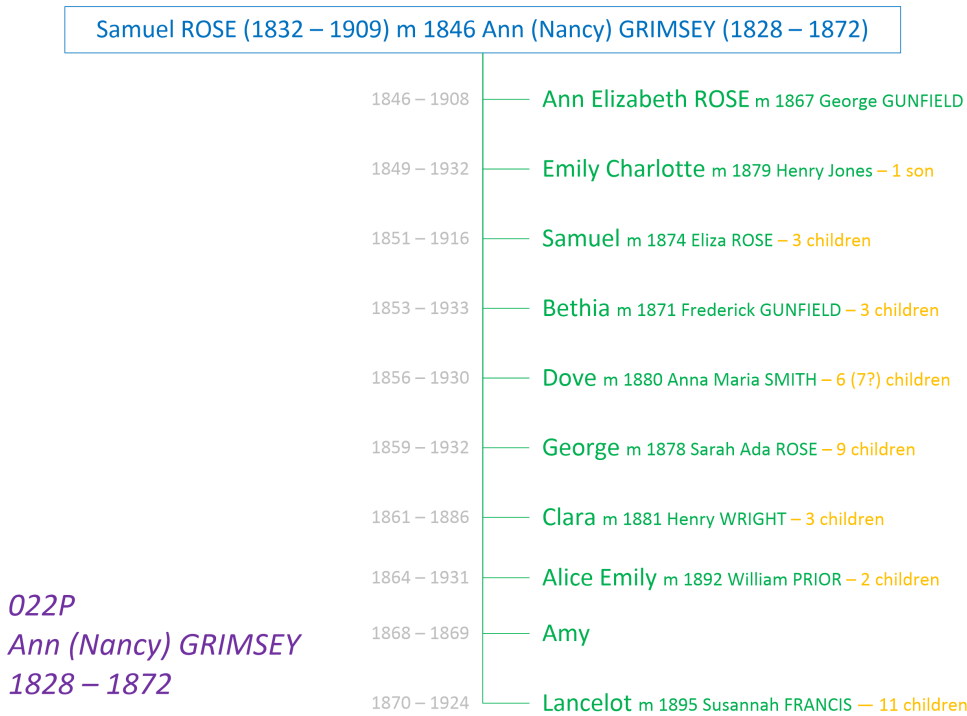
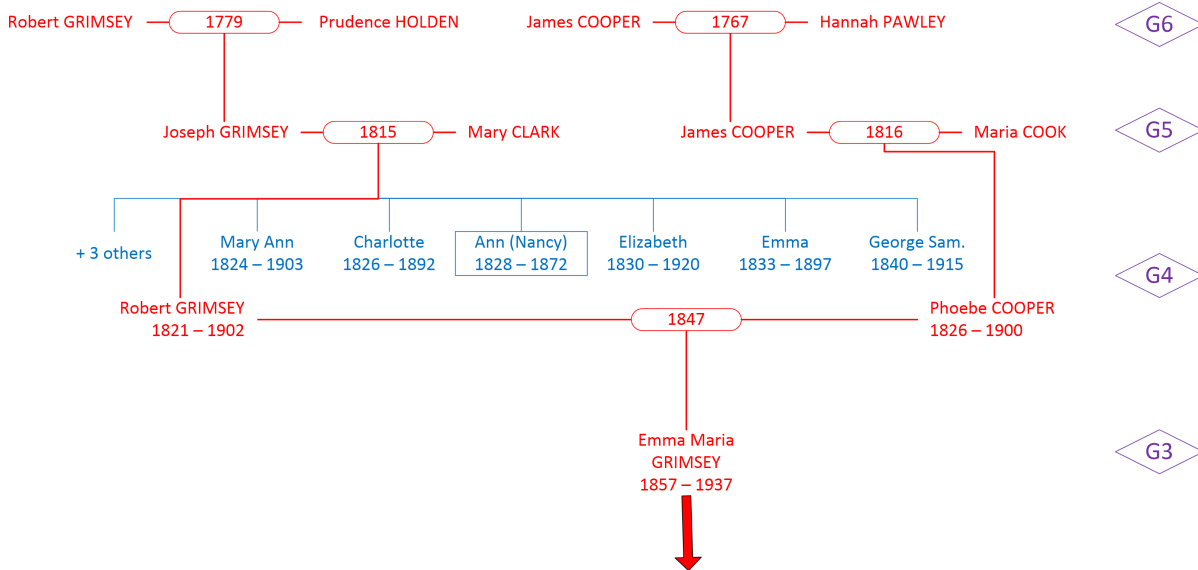

Samuel ROSE (1832 – 1909) m 1846 Ann (Nancy) GRIMSEY (1828 – 1872)

- 1846 – 1908 — Ann Elizabeth ROSE m 1867 George GUNFIELD
- 1849 – 1932 — Emily Charlotte m 1879 Henry Jones — 1 son
- 1851 – 1916 — Samuel m 1874 Eliza ROSE — 3 children
- 1853 – 1933 — Bethia m 1871 Frederick GUNFIELD — 3 children
- 1856 – 1930 — Dove m 1880 Anna Maria SMITH — 6 (7?) children
- 1859 – 1932 — George m 1878 Sarah Ada ROSE — 9 children
- 1861 – 1886 — Clara m 1881 Henry WRIGHT — 3 children
- 1864 – 1931 — Alice Emily m 1892 William PRIOR — 2 children
- 1868 – 1869 — Amy
- 1870 – 1924 — Lancelot m 1895 Susannah FRANCIS — 11 children

022P

Ann (Nancy) GRIMSEY  
1828 – 1872

Samuel ROSE (1832 – 1909) m 1846 Ann (Nancy) GRIMSEY (1828 – 1872)

- 1846 – 1908 — Ann Elizabeth ROSE m 1867 George GUNFIELD
- 1849 – 1932 — Emily Charlotte m 1879 Henry Jones — 1 son
- 1851 – 1916 — Samuel m 1874 Eliza ROSE — 3 children
- 1853 – 1933 — Bethia m 1871 Frederick GUNFIELD — 3 children
- 1856 – 1930 — Dove m 1880 Anna Maria SMITH — 6 (7?) children
- 1859 – 1932 — George m 1878 Sarah Ada ROSE — 9 children
- 1861 – 1886 — Clara m 1881 Henry WRIGHT — 3 children
- 1864 – 1931 — Alice Emily m 1892 William PRIOR — 2 children
- 1868 – 1869 — Amy
- 1870 – 1924 — Lancelot m 1895 Susannah FRANCIS — 11 children

022P

Ann (Nancy) GRIMSEY  
1828 – 1872

Samuel ROSE (1832 – 1909) m 1846 Ann (Nancy) GRIMSEY (1828 – 1872)

- 1846 – 1908 — Ann Elizabeth ROSE m 1867 George GUNFIELD
- 1849 – 1932 — Emily Charlotte m 1879 Henry Jones — 1 son
- 1851 – 1916 — Samuel m 1874 Eliza ROSE — 3 children
- 1853 – 1933 — Bethia m 1871 Frederick GUNFIELD — 3 children
- 1856 – 1930 — Dove m 1880 Anna Maria SMITH — 6 (7?) children
- 1859 – 1932 — George m 1878 Sarah Ada ROSE — 9 children
- 1861 – 1886 — Clara m 1881 Henry WRIGHT — 3 children
- 1864 – 1931 — Alice Emily m 1892 William PRIOR — 2 children
- 1868 – 1869 — Amy
- 1870 – 1924 — Lancelot m 1895 Susannah FRANCIS — 11 children

022P

Ann (Nancy) GRIMSEY  
1828 – 1872

Samuel ROSE (1832 – 1909) m 1846 Ann (Nancy) GRIMSEY (1828 – 1872)

- 1846 – 1908 — Ann Elizabeth ROSE m 1867 George GUNFIELD
- 1849 – 1932 — Emily Charlotte m 1879 Henry Jones — 1 son
- 1851 – 1916 — Samuel m 1874 Eliza ROSE — 3 children
- 1853 – 1933 — Bethia m 1871 Frederick GUNFIELD — 3 children
- 1856 – 1930 — Dove m 1880 Anna Maria SMITH — 6 (7?) children
- 1859 – 1932 — George m 1878 Sarah Ada ROSE — 9 children
- 1861 – 1886 — Clara m 1881 Henry WRIGHT — 3 children
- 1864 – 1931 — Alice Emily m 1892 William PRIOR — 2 children
- 1868 – 1869 — Amy
- 1870 – 1924 — Lancelot m 1895 Susannah FRANCIS — 11 children

022P

Ann (Nancy) GRIMSEY  
1828 – 1872



Samuel ROSE (1832 – 1909) m 1846 Ann (Nancy) GRIMSEY (1828 – 1872)

- 1846 – 1908 — Ann Elizabeth ROSE m 1867 George GUNFIELD
- 1849 – 1932 — Emily Charlotte m 1879 Henry Jones — 1 son
- 1851 – 1916 — Samuel m 1874 Eliza ROSE — 3 children
- 1853 – 1933 — Bethia m 1871 Frederick GUNFIELD — 3 children
- 1856 – 1930 — Dove m 1880 Anna Maria SMITH — 6 (7?) children
- 1859 – 1932 — George m 1878 Sarah Ada ROSE — 9 children
- 1861 – 1886 — Clara m 1881 Henry WRIGHT — 3 children
- 1864 – 1931 — Alice Emily m 1892 William PRIOR — 2 children
- 1868 – 1869 — Amy
- 1870 – 1924 — Lancelot m 1895 Susannah FRANCIS — 11 children

022P

Ann (Nancy) GRIMSEY  
1828 – 1872

Samuel ROSE (1832 – 1909) m 1846 Ann (Nancy) GRIMSEY (1828 – 1872)

1846 – 1908 — Ann Elizabeth ROSE m 1867 George GUNFIELD  
1849 – 1932 — Emily Charlotte m 1879 Henry Jones — 1 son  
1851 – 1916 — Samuel m 1874 Eliza ROSE — 3 children  
1853 – 1933 — Bethia m 1871 Frederick GUNFIELD — 3 children  
1856 – 1930 — Dove m 1880 Anna Maria SMITH — 6 (??) children  
1859 – 1932 — George m 1878 Sarah Ada ROSE — 9 children  
1861 – 1886 — Clara m 1881 Henry WRIGHT — 3 children  
1864 – 1931 — Alice Emily m 1892 William PRIOR — 2 children  
1868 – 1869 — Amy  
1870 – 1924 — Lancelot m 1895 Susannah FRANCIS — 11 children

022P  
Ann (Nancy) GRIMSEY  
1828 – 1872

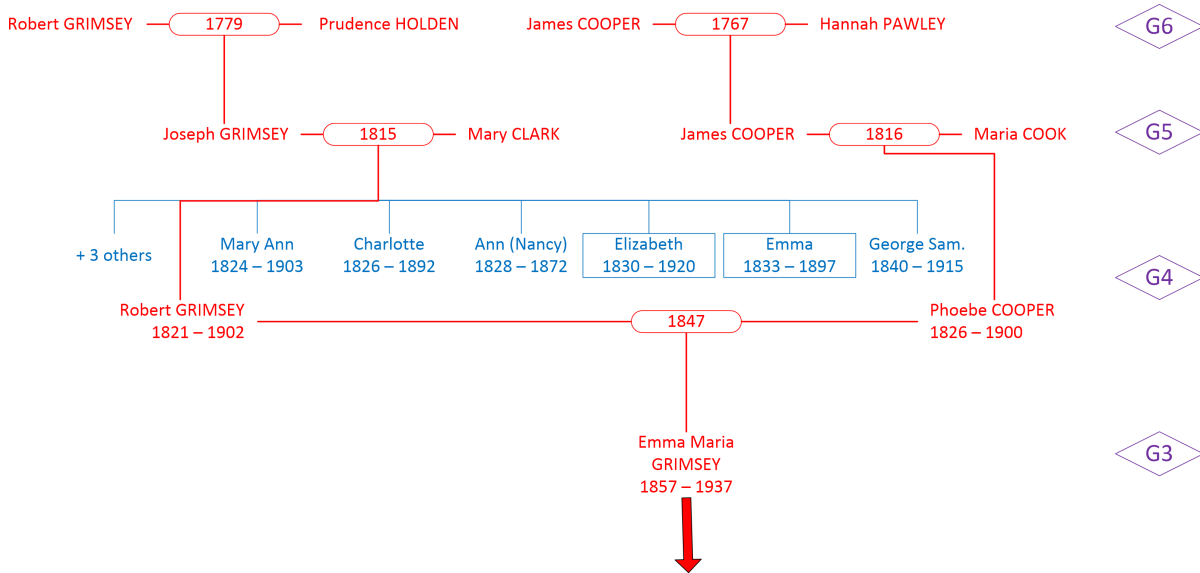

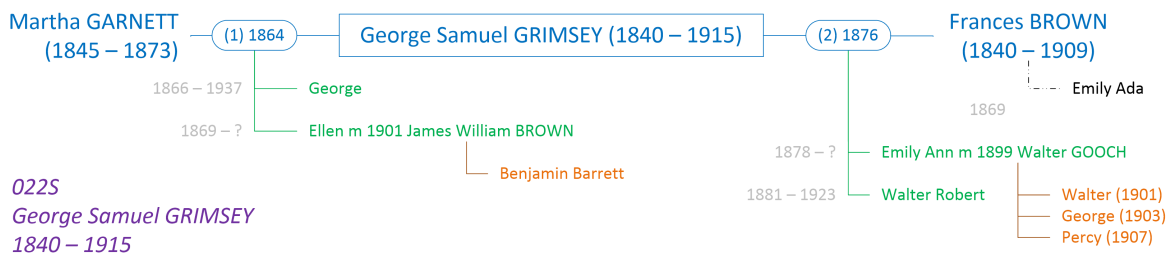
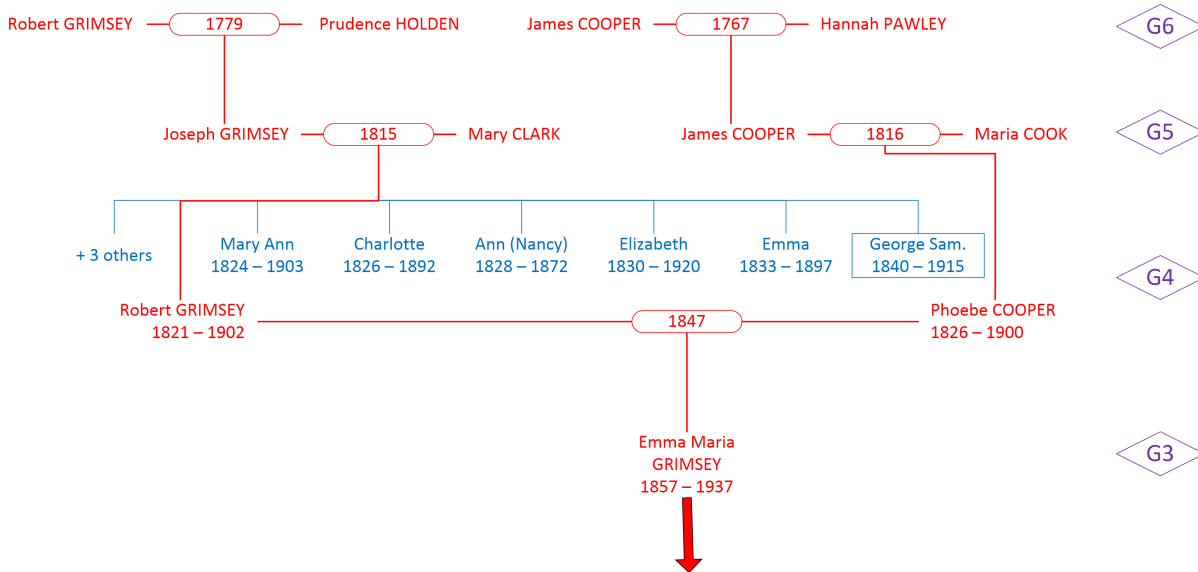

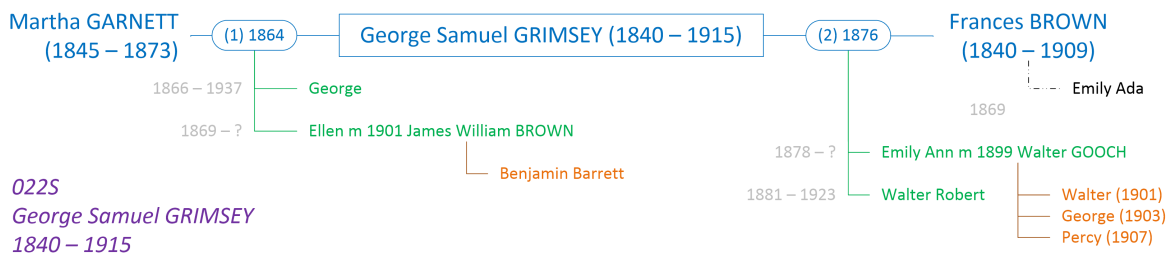

0225  
*George Samuel GRIMSEY*  
 1840 – 1915

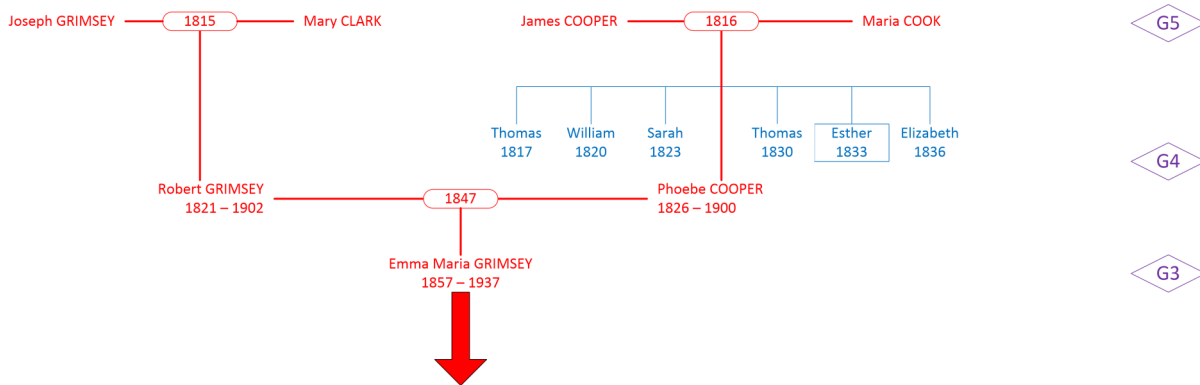

### Esther COOPER (1833 – 1911)

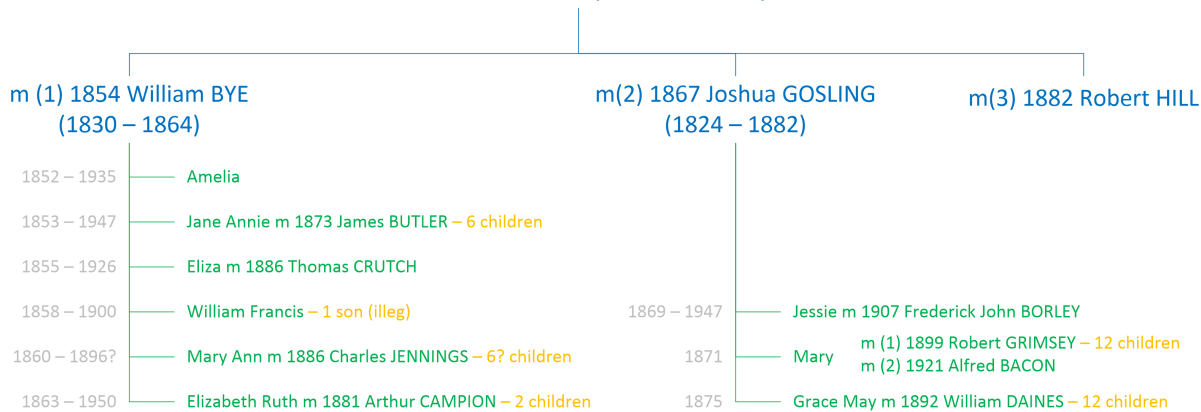

0230  
*Esther COOPER*  
 1833 – 1899

Esther COOPER (1833 – 1911)

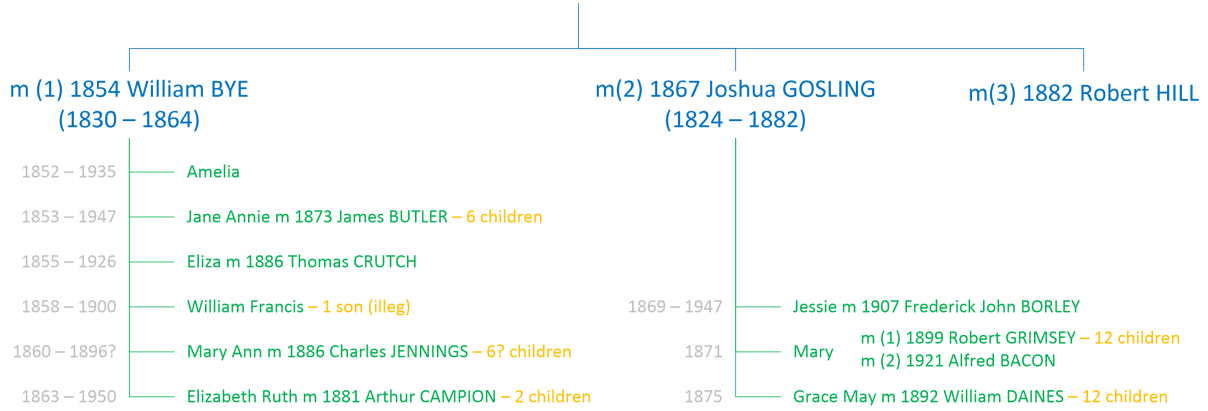

0230  
 Esther COOPER  
 1833 – 1899

Esther COOPER (1833 – 1911)

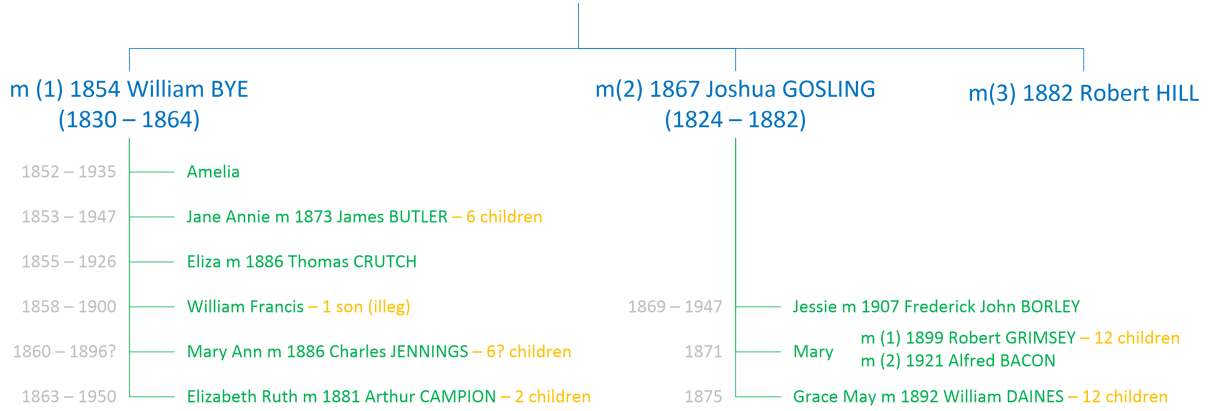

0230  
 Esther COOPER  
 1833 – 1899



Esther COOPER (1833 – 1911)

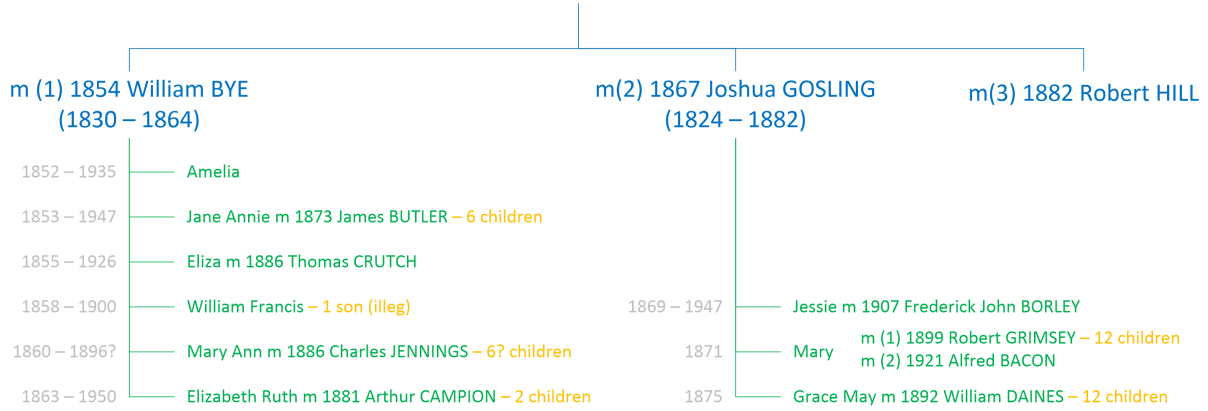

0230  
 Esther COOPER  
 1833 – 1899

Esther COOPER (1833 – 1911)

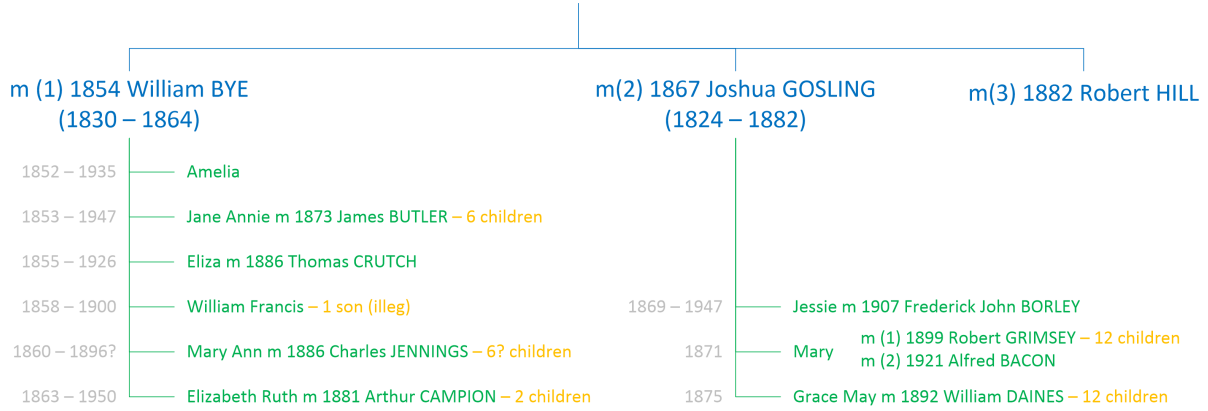

0230  
 Esther COOPER  
 1833 – 1899

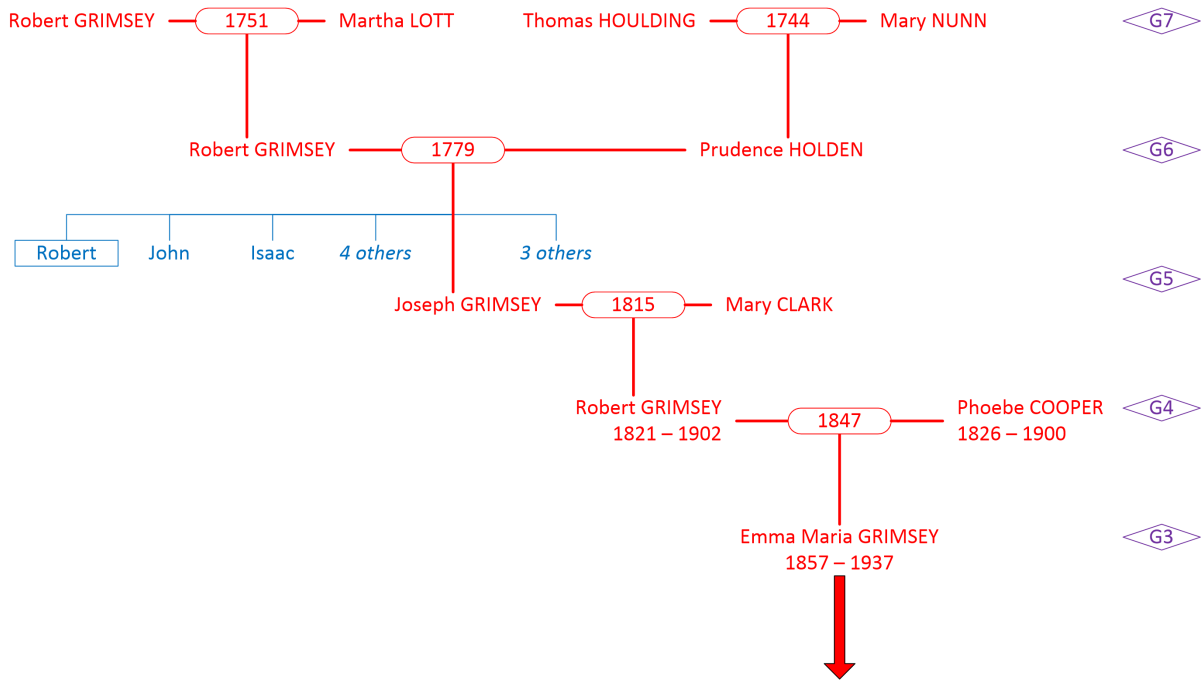

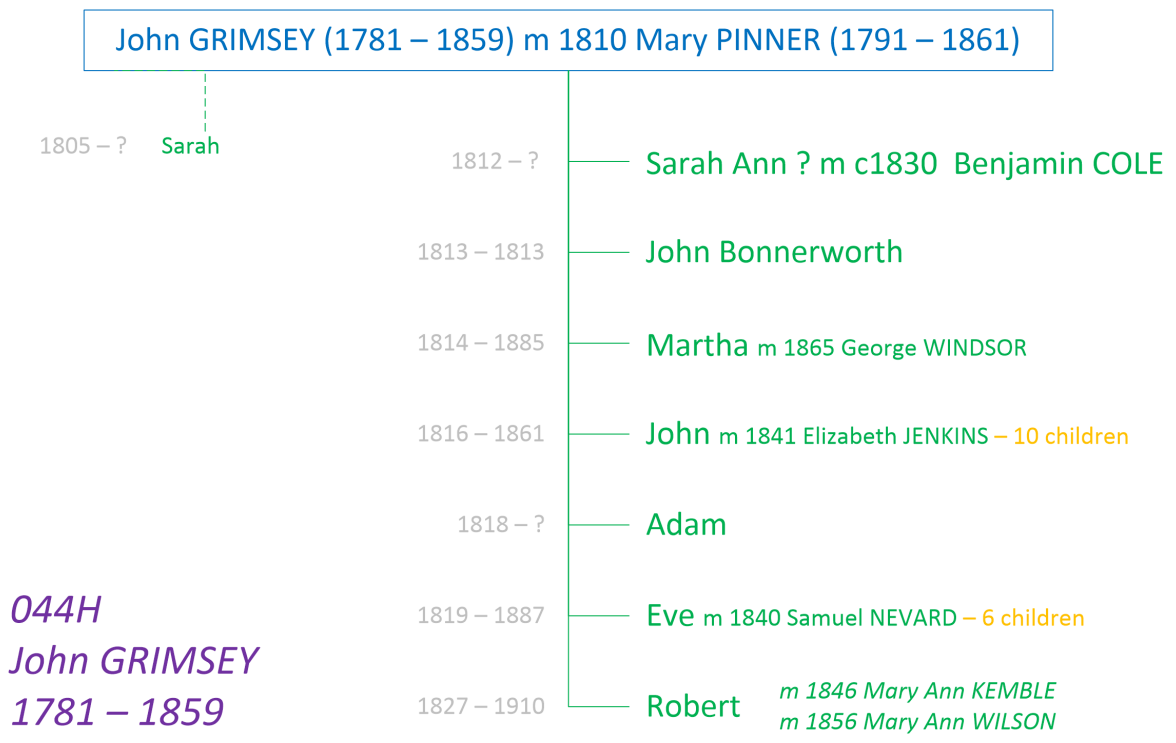
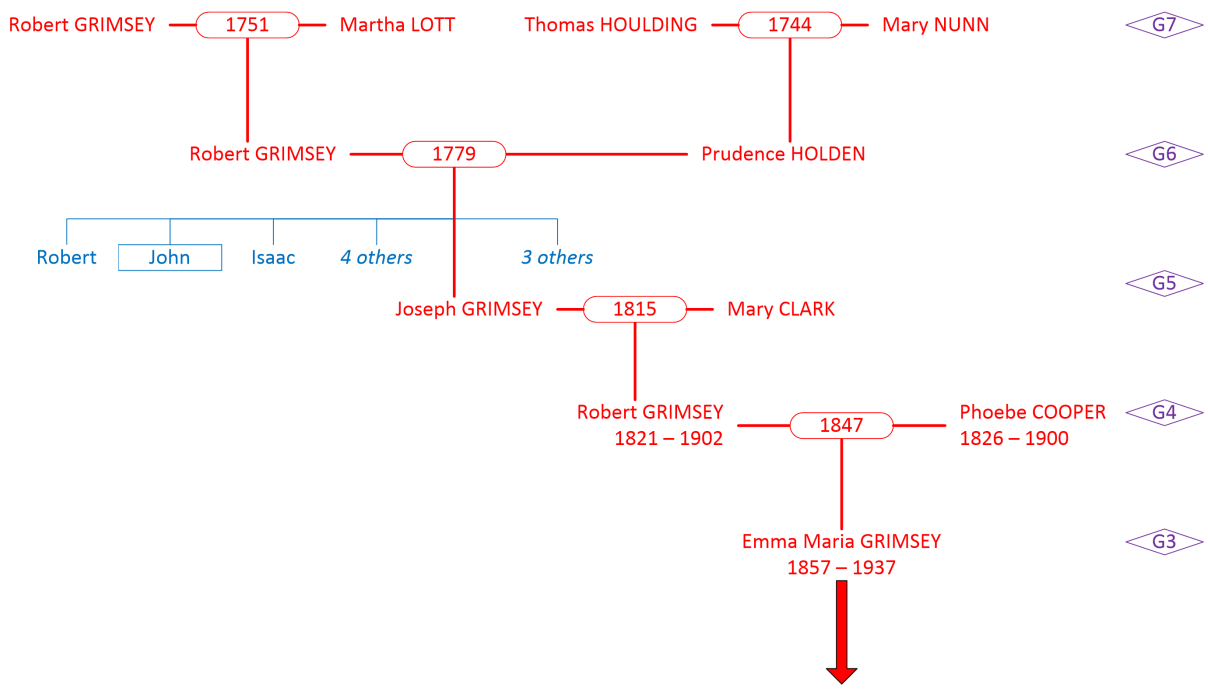

John GRIMSEY (1781 – 1859) m 1810 Mary PINNER (1791 – 1861)

1805 – ? Sarah

1812 – ? Sarah Ann ? m c1830 Benjamin COLE

1813 – 1813 John Bonnerworth

1814 – 1885 Martha m 1865 George WINDSOR

1816 – 1861 John m 1841 Elizabeth JENKINS – 10 children

1818 – ? Adam

1819 – 1887 Eve m 1840 Samuel NEVARD – 6 children

1827 – 1910 Robert m 1846 Mary Ann KEMBLE  
m 1856 Mary Ann WILSON

044H  
John GRIMSEY  
1781 – 1859

John GRIMSEY (1781 – 1859) m 1810 Mary PINNER (1791 – 1861)

1805 – ? Sarah

1812 – ? Sarah Ann ? m c1830 Benjamin COLE

1813 – 1813 John Bonnerworth

1814 – 1885 Martha m 1865 George WINDSOR

1816 – 1861 John m 1841 Elizabeth JENKINS – 10 children

1818 – ? Adam

1819 – 1887 Eve m 1840 Samuel NEVARD – 6 children

1827 – 1910 Robert m 1846 Mary Ann KEMBLE  
m 1856 Mary Ann WILSON

044H  
John GRIMSEY  
1781 – 1859

John GRIMSEY (1781 – 1859) m 1810 Mary PINNER (1791 – 1861)

1805 – ? Sarah

1812 – ? Sarah Ann ? m c1830 Benjamin COLE

1813 – 1813 John Bonnerworth

1814 – 1885 Martha m 1865 George WINDSOR

1816 – 1861 John m 1841 Elizabeth JENKINS – 10 children

1818 – ? Adam

1819 – 1887 Eve m 1840 Samuel NEVARD – 6 children

1827 – 1910 Robert m 1846 Mary Ann KEMBLE  
m 1856 Mary Ann WILSON

044H  
John GRIMSEY  
1781 – 1859

John GRIMSEY (1781 – 1859) m 1810 Mary PINNER (1791 – 1861)

1805 – ? Sarah

1812 – ? Sarah Ann ? m c1830 Benjamin COLE

1813 – 1813 John Bonnerworth

1814 – 1885 Martha m 1865 George WINDSOR

1816 – 1861 John m 1841 Elizabeth JENKINS – 10 children

1818 – ? Adam

1819 – 1887 Eve m 1840 Samuel NEVARD – 6 children

1827 – 1910 Robert m 1846 Mary Ann KEMBLE  
m 1856 Mary Ann WILSON

044H  
John GRIMSEY  
1781 – 1859



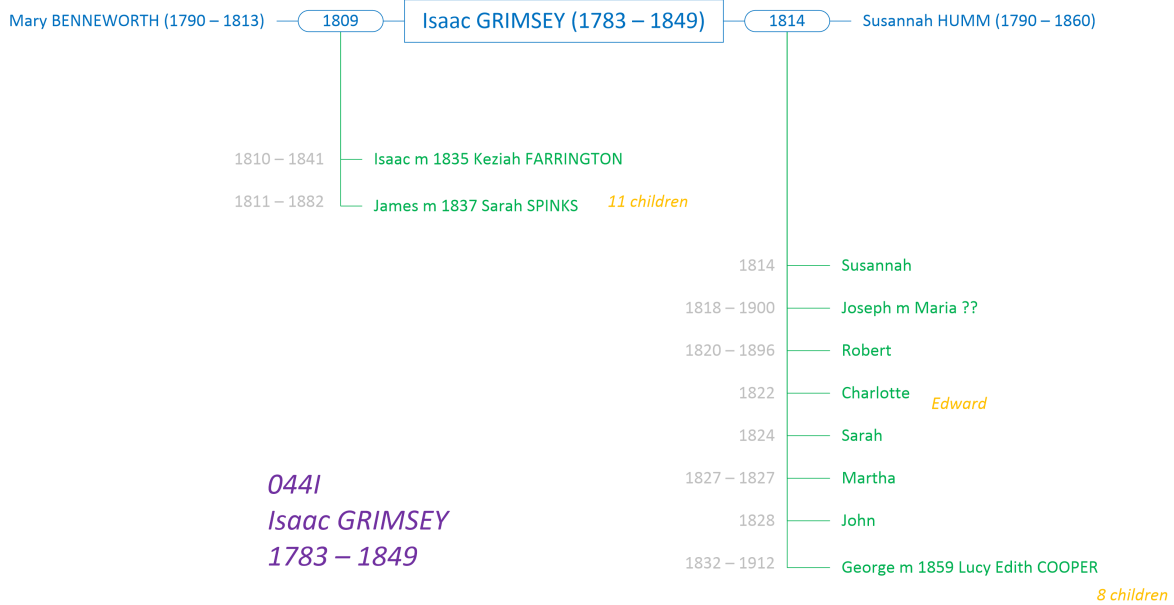
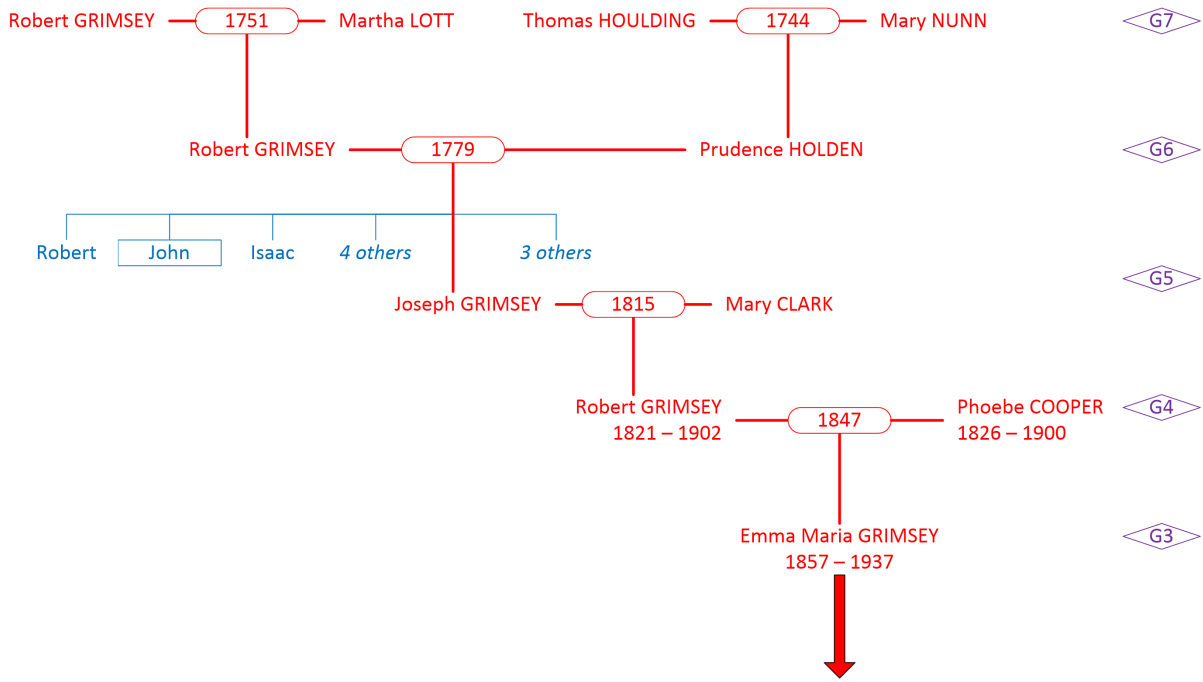

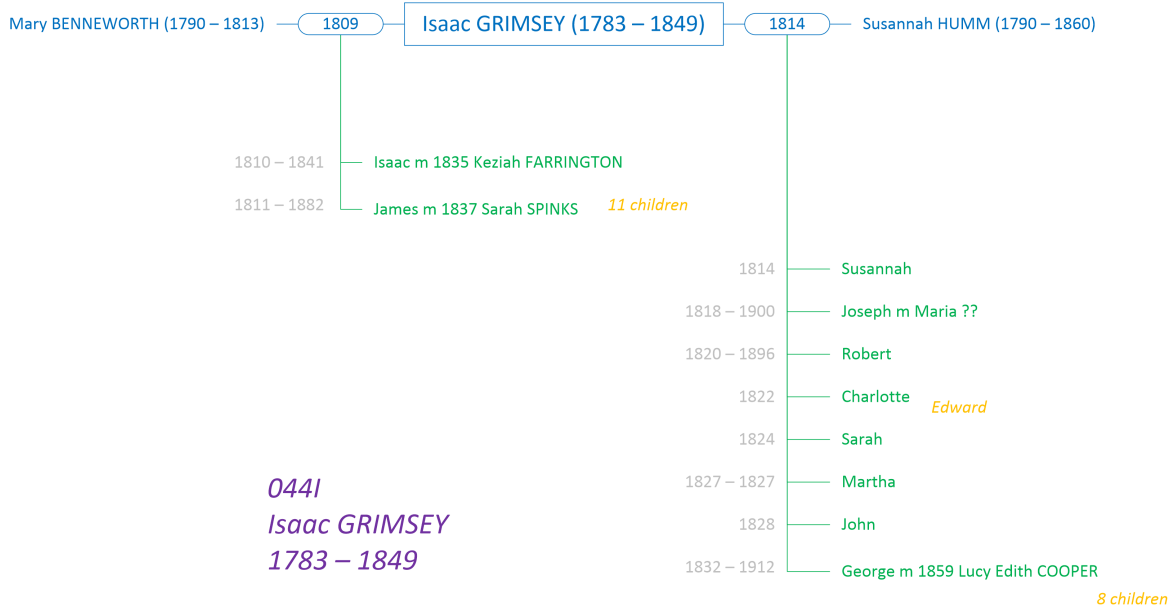

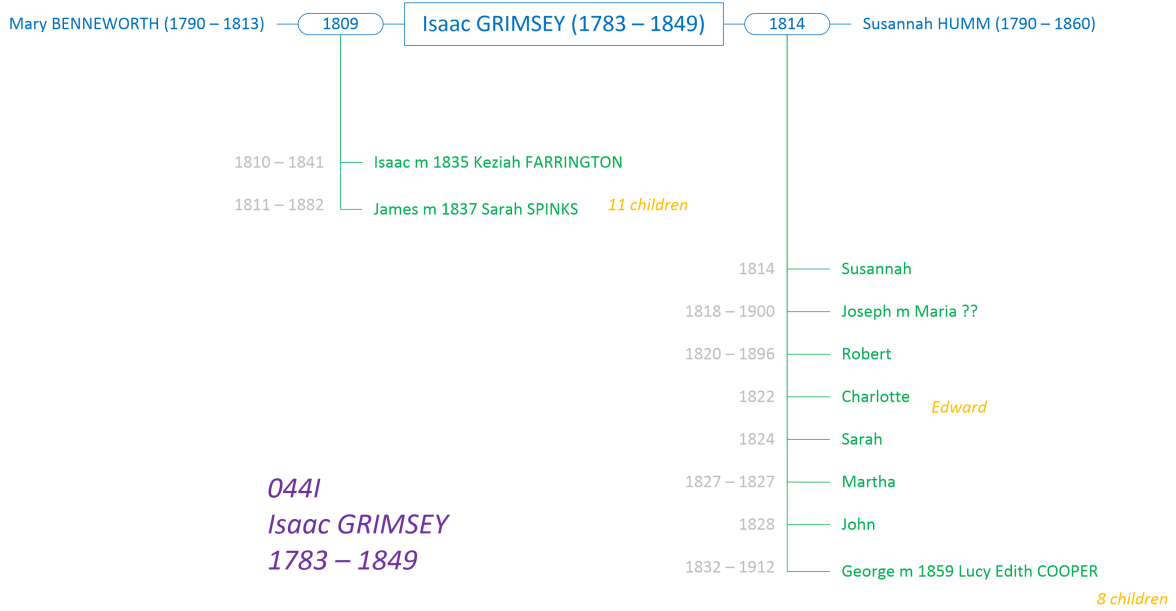

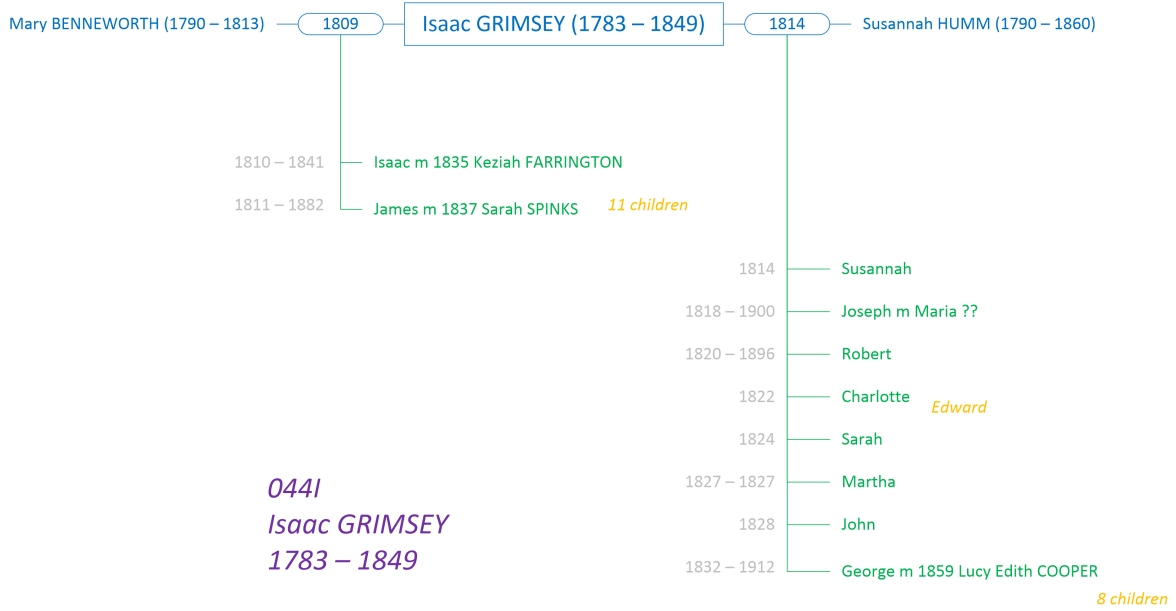

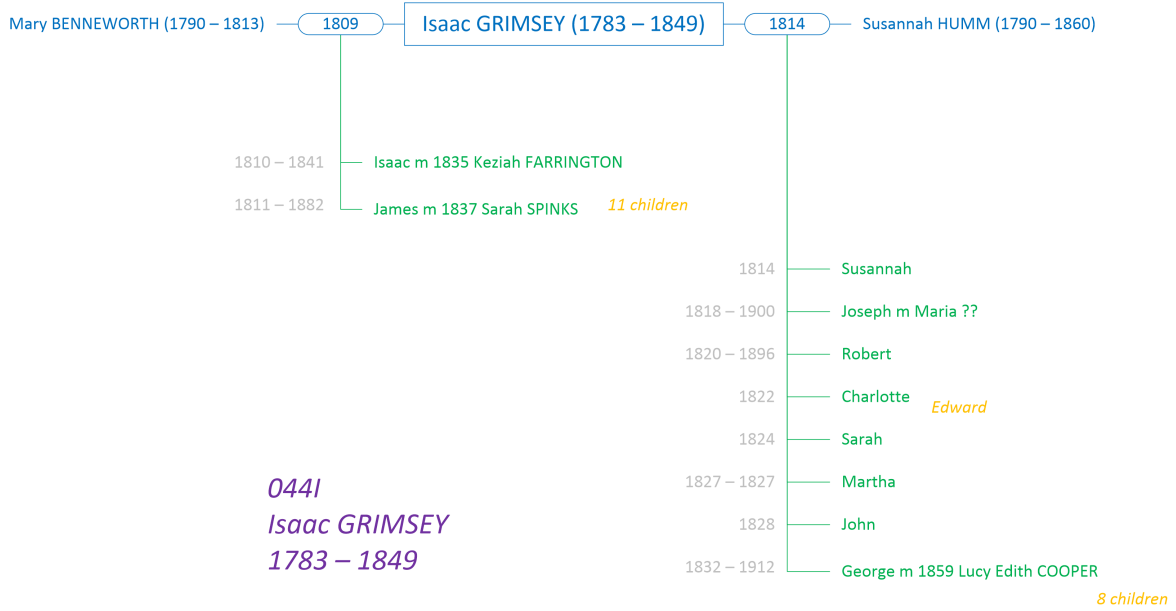

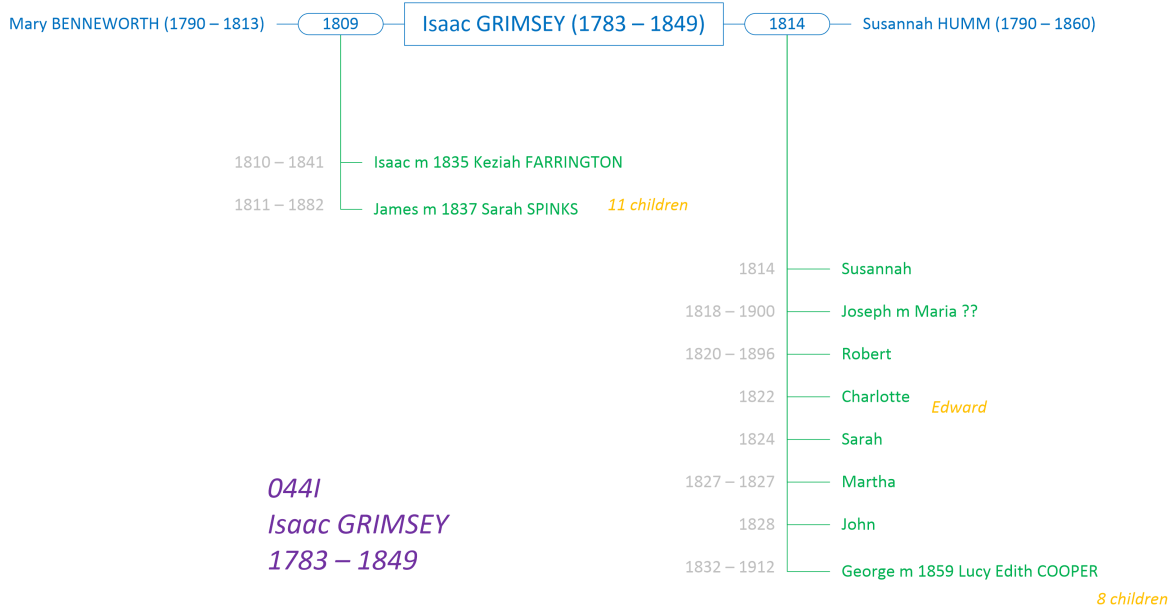

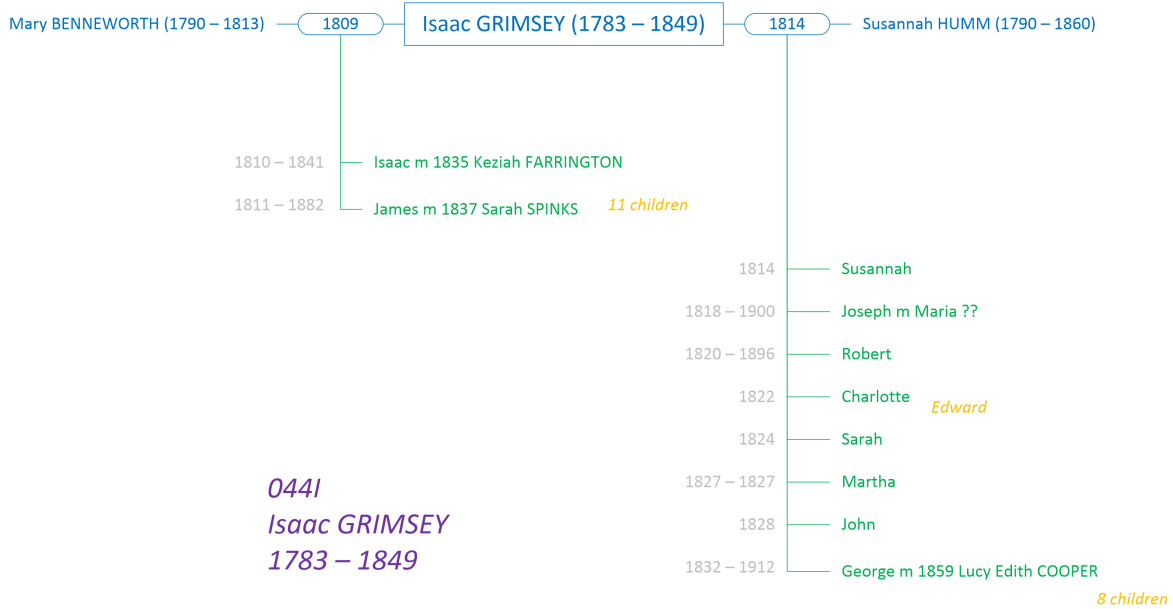

George GRIMSEY (1832 – 1912) m 1859 Lucy Edith COOPER (1836 – 1909)

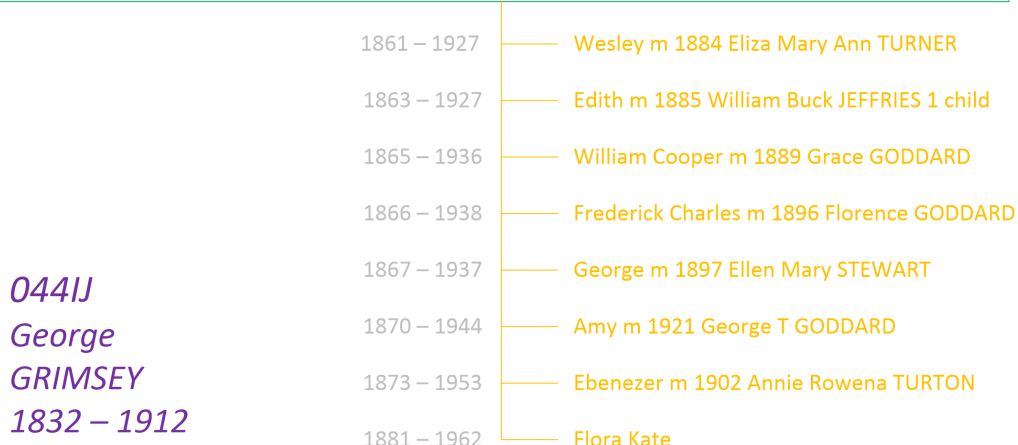

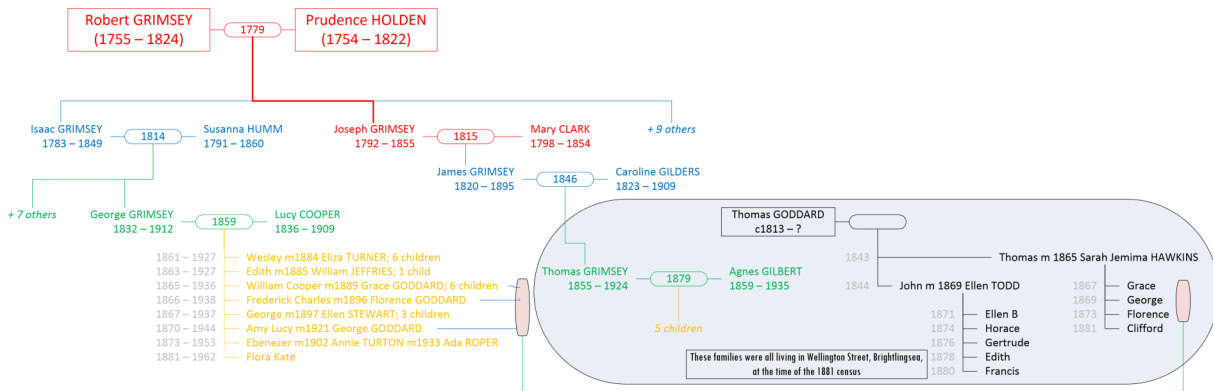
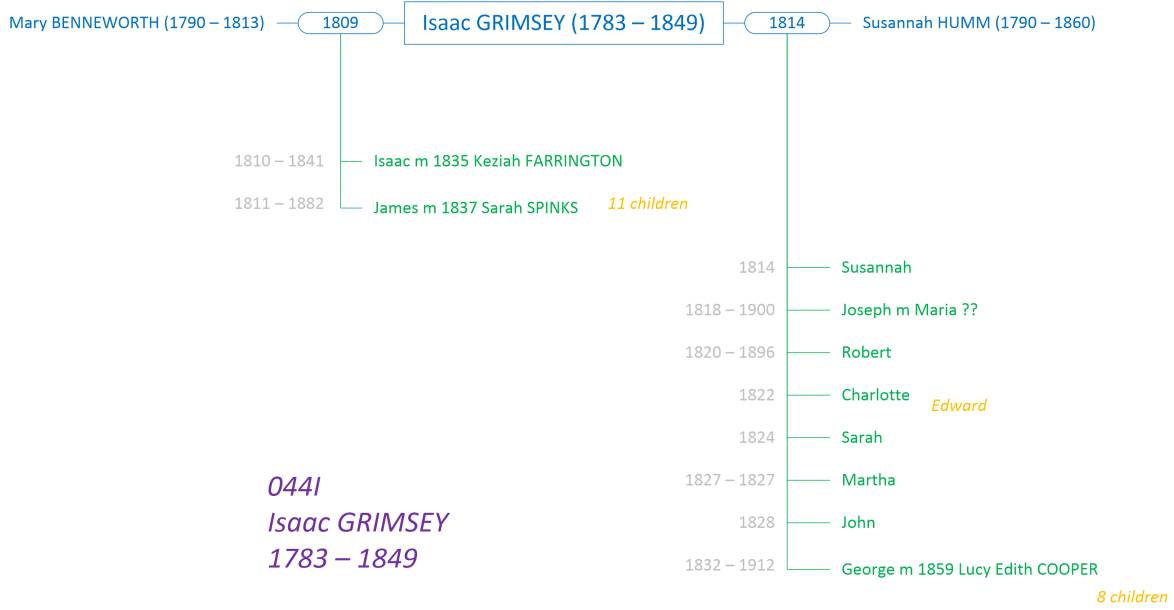



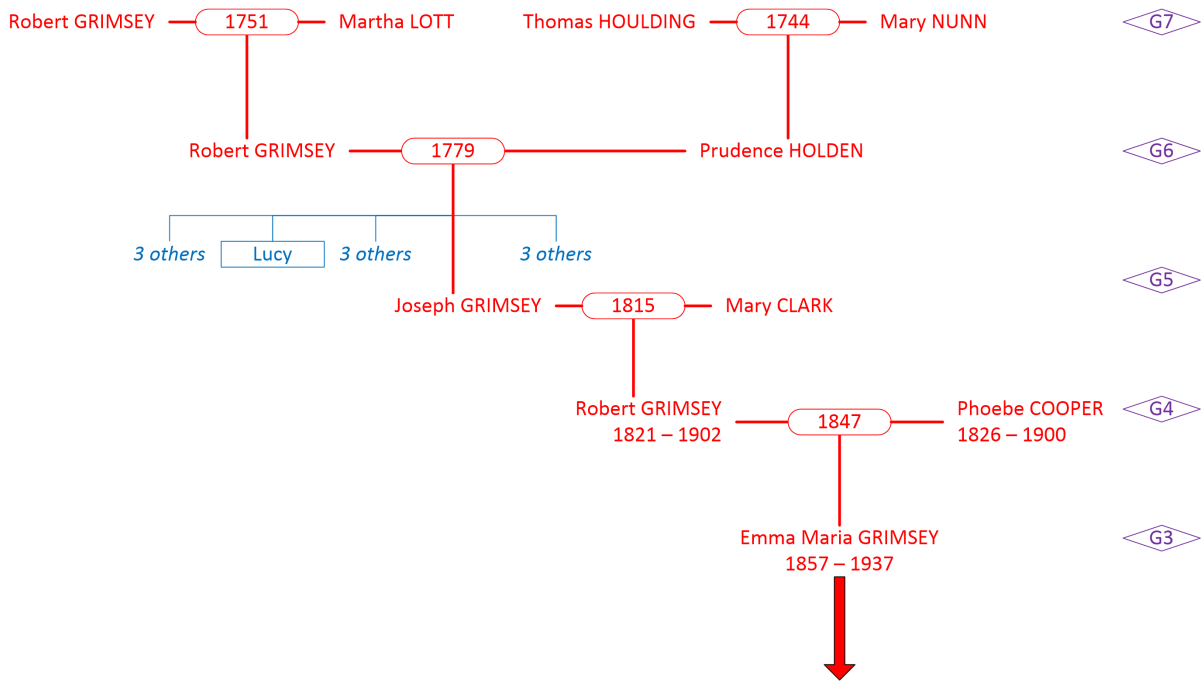

James TILLET (1781 – 1839) m 1815 Lucy GRIMSEY (1784 – 1867)

**044J**  
**Lucy GRIMSEY**  
**1784 – 1867**

- 1816 – 1903 — James m 1838 Ann COPPIN – 9 children
- 1819 – 1899 — Jesse m 1846 Tamar GILBERT – 8 children
- 1822 – 1899 — Caroline m 1846 Thomas JENNINGS – 7 children
- 1823 – 1905 — Susan m 1844 Benjamin WELHAM – 10 children
- 1828 – 1828 — Joseph
- 1829 – 1839 — Charles
- 1831 – 1844 — Rachel

James TILLETT (1781 – 1839) m 1815 Lucy GRIMSEY (1784 – 1867)

1816 – 1903 — James m 1838 Ann COPPIN – 9 children  
1819 – 1899 — Jesse m 1846 Tamar GILBERT – 8 children  
1822 – 1899 — Caroline m 1846 Thomas JENNINGS – 7 children  
1823 – 1905 — Susan m 1844 Benjamin WELHAM – 10 children  
1828 – 1828 — Joseph  
1829 – 1839 — Charles  
1831 – 1844 — Rachel

**044J**  
**Lucy GRIMSEY**  
**1784 – 1867**

James TILLET (1781 – 1839) m 1815 Lucy GRIMSEY (1784 – 1867)

1816 – 1903 — James m 1838 Ann COPPIN – 9 children  
1819 – 1899 — Jesse m 1846 Tamar GILBERT – 8 children  
1822 – 1899 — Caroline m 1846 Thomas JENNINGS – 7 children  
1823 – 1905 — Susan m 1844 Benjamin WELHAM – 10 children  
1828 – 1828 — Joseph  
1829 – 1839 — Charles  
1831 – 1844 — Rachel

**044J**  
**Lucy GRIMSEY**  
**1784 – 1867**

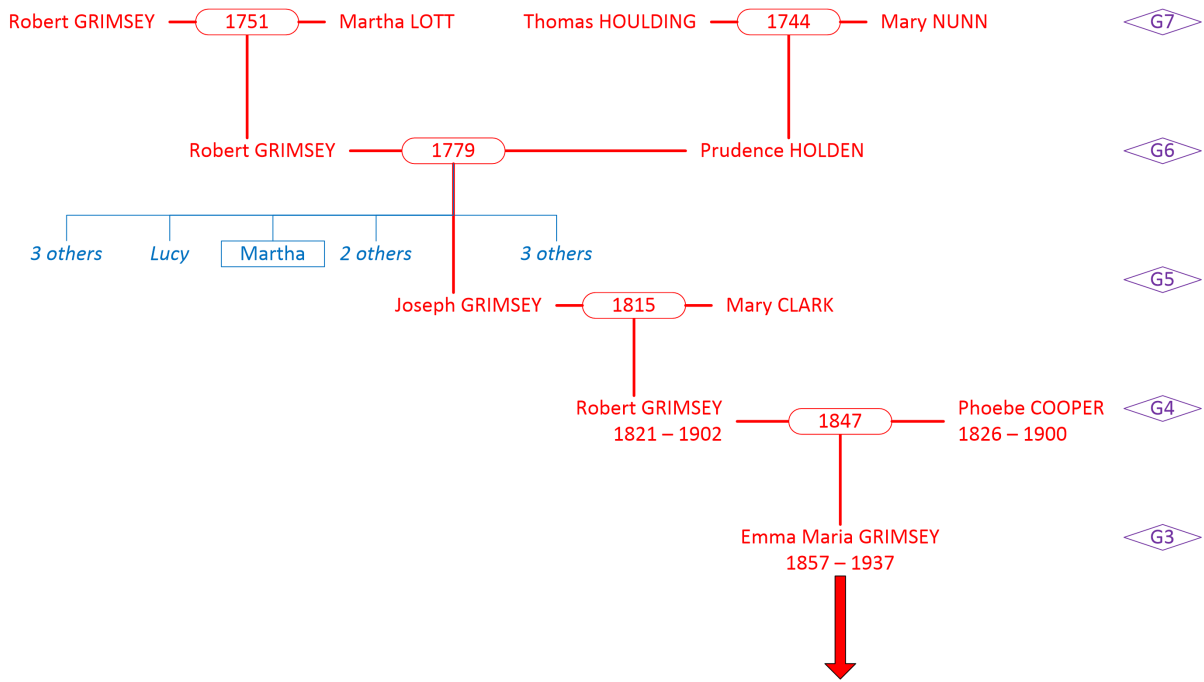

Bruce PULFIER (1787 – 1860) m 1815 Martha GRIMSEY (1787 – 1875)

044K  
Martha GRIMSEY  
1787 – 1875

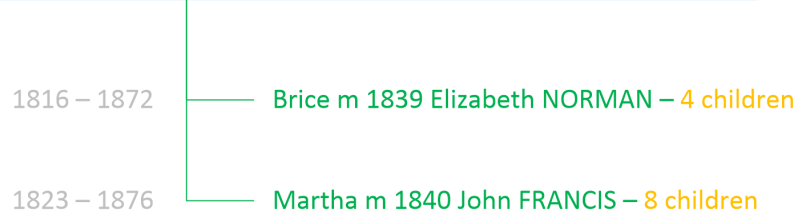



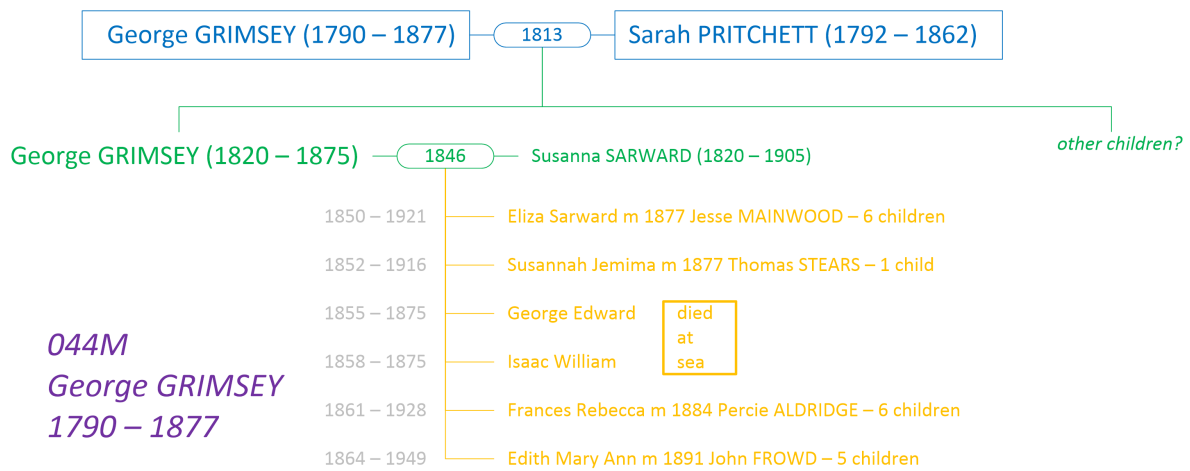
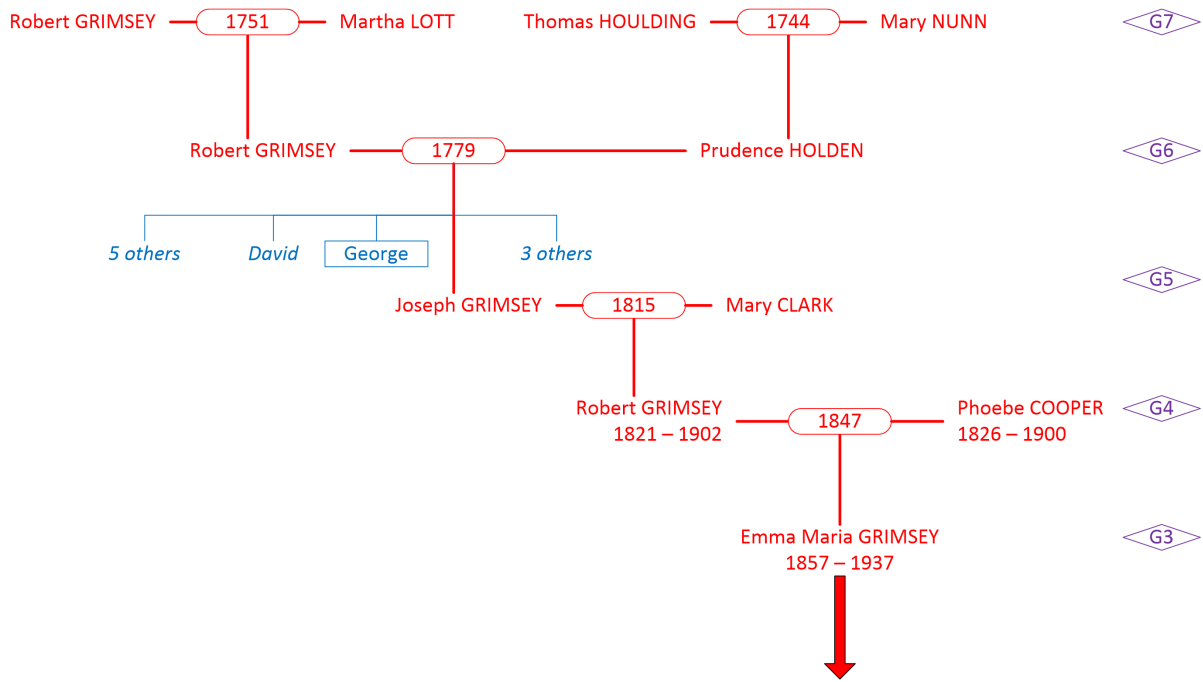

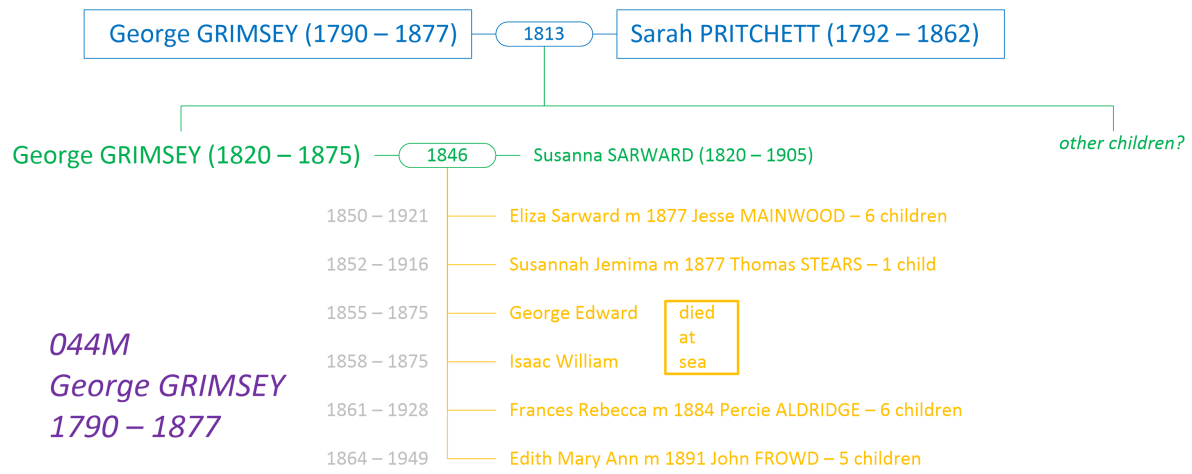

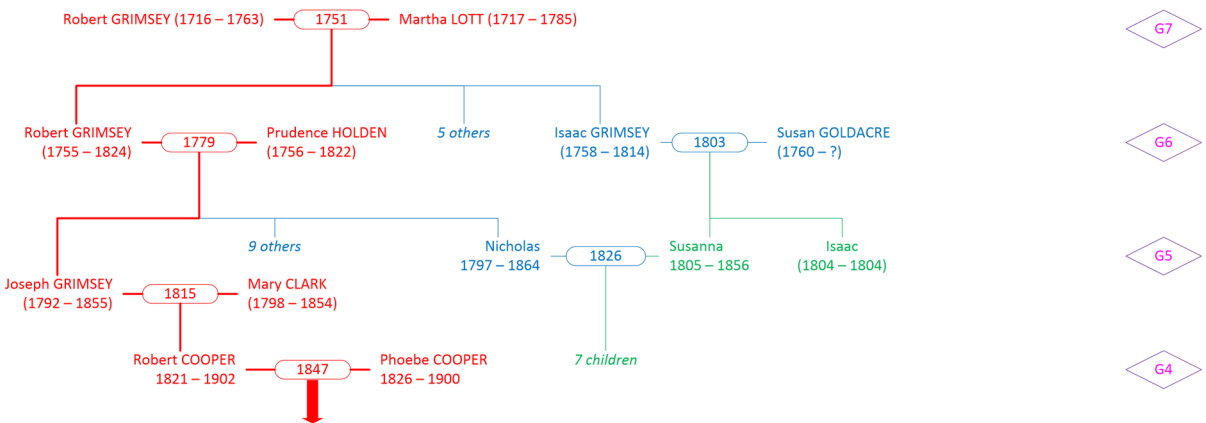
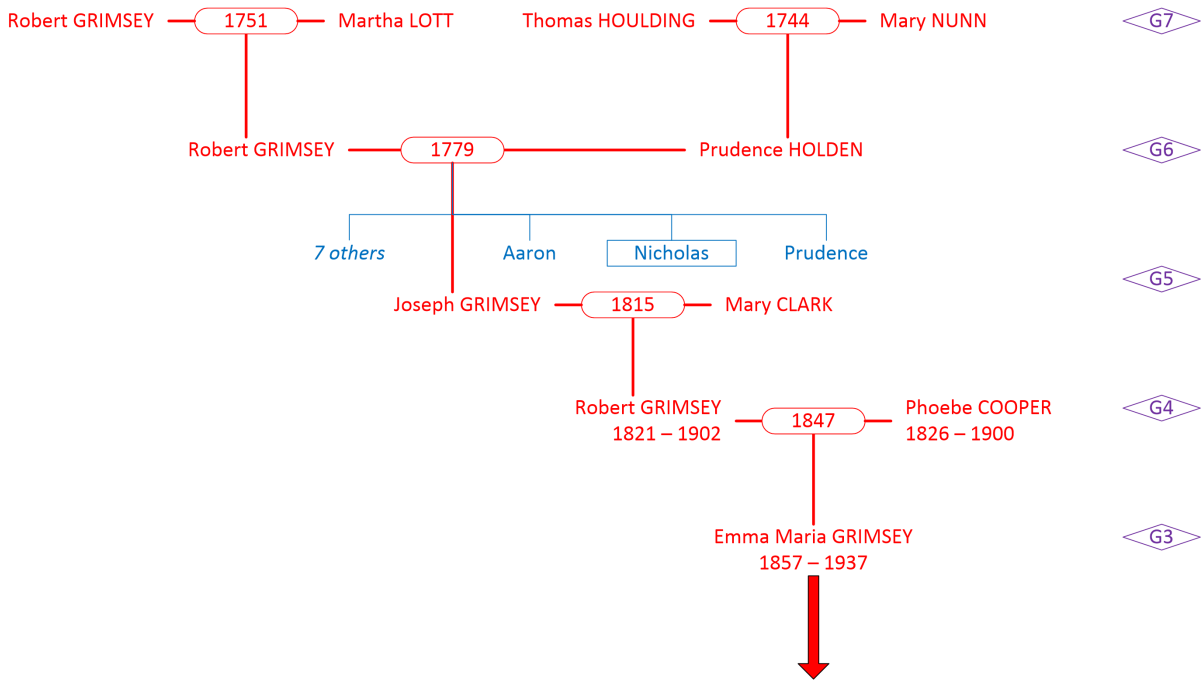

Nicholas GRIMSEY (1797 – 1864) m 1826 Susanna GRIMSEY (1805 – 1856)

- 1828 – 1886 — Isaac m 1860 Sarah COCKRELL
- 1829 – 1829 — Susanne
- 1830 – 1847 — Robert
- 1833 – 1851 — Susanna
- 1835 – 1858 — Sarah Ann
- 1842 – 1844 — Nicholas William
- 1847 – 1853 — Mary Ann

0440  
Nicholas GRIMSEY  
1797 – 1864



Nicholas GRIMSEY (1797 – 1864) m 1826 Susanna GRIMSEY (1805 – 1856)

1828 – 1886	—	Isaac m 1860 Sarah COCKRELL
1829 – 1829	—	Susanne
1830 – 1847	—	Robert
1833 – 1851	—	Susanna
1835 – 1858	—	Sarah Ann
1842 – 1844	—	Nicholas William
1847 – 1853	—	Mary Ann

0440  
Nicholas GRIMSEY  
1797 – 1864

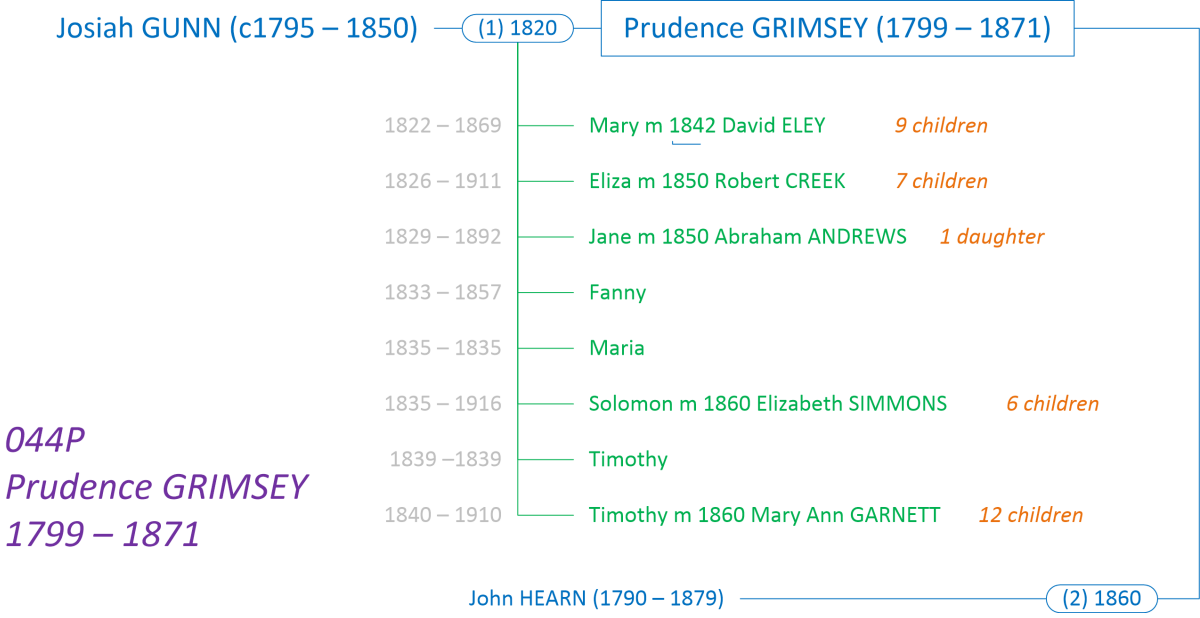
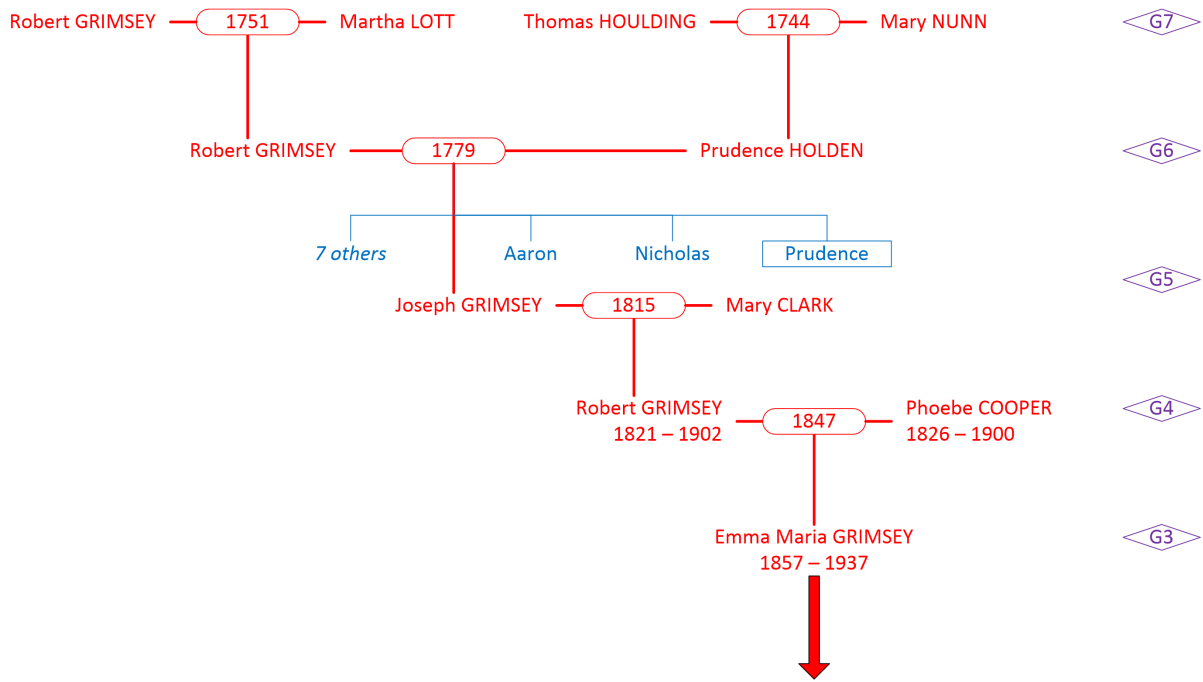

044P  
 Prudence GRIMSEY  
 1799 – 1871

Josiah GUNN (c1795 – 1850)

(1) 1820

Prudence GRIMSEY (1799 – 1871)

1822 – 1869

Mary m 1842 David ELEY

9 children

1826 – 1911

Eliza m 1850 Robert CREEK

7 children

1829 – 1892

Jane m 1850 Abraham ANDREWS

1 daughter

1833 – 1857

Fanny

1835 – 1835

Maria

1835 – 1916

Solomon m 1860 Elizabeth SIMMONS

6 children

1839 – 1839

Timothy

1840 – 1910

Timothy m 1860 Mary Ann GARNETT

12 children

John HEARN (1790 – 1879)

(2) 1860

044P

Prudence GRIMSEY  
1799 – 1871

Josiah GUNN (c1795 – 1850)

(1) 1820

Prudence GRIMSEY (1799 – 1871)

1822 – 1869

Mary m 1842 David ELEY

9 children

1826 – 1911

Eliza m 1850 Robert CREEK

7 children

1829 – 1892

Jane m 1850 Abraham ANDREWS

1 daughter

1833 – 1857

Fanny

1835 – 1835

Maria

1835 – 1916

Solomon m 1860 Elizabeth SIMMONS

6 children

1839 – 1839

Timothy

1840 – 1910

Timothy m 1860 Mary Ann GARNETT

12 children

John HEARN (1790 – 1879)

(2) 1860

044P

Prudence GRIMSEY  
1799 – 1871

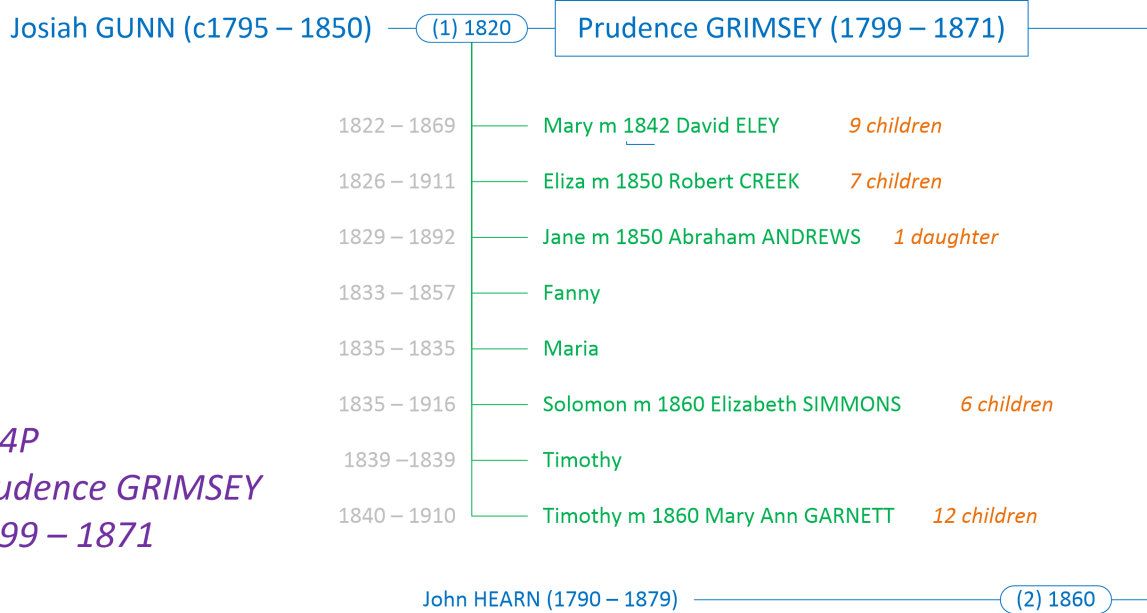

044P  
 Prudence GRIMSEY  
 1799 – 1871

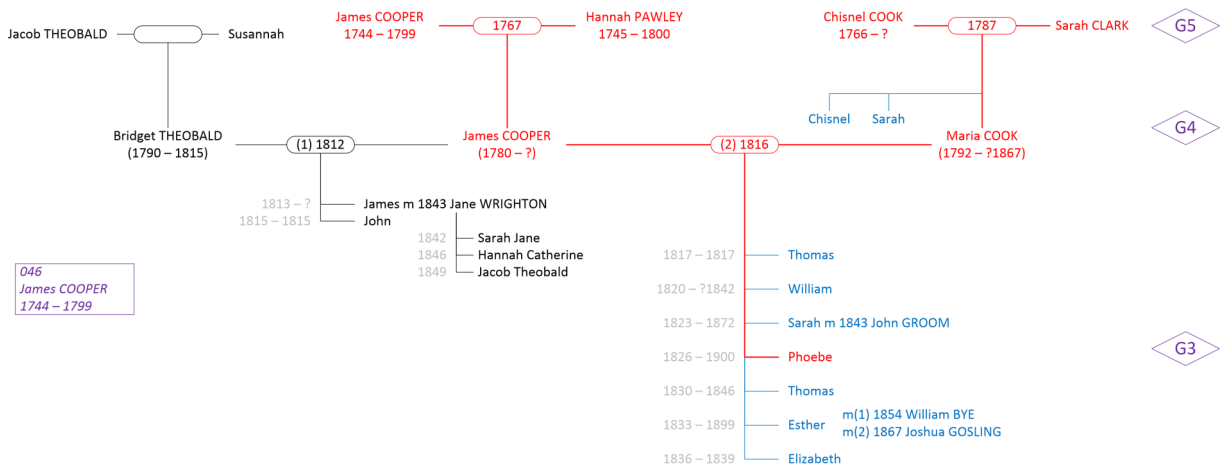
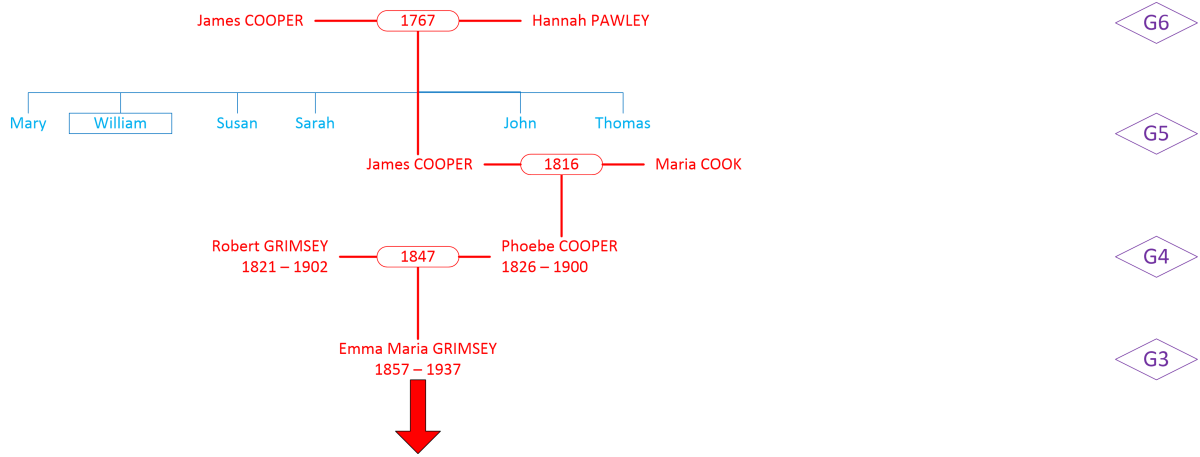

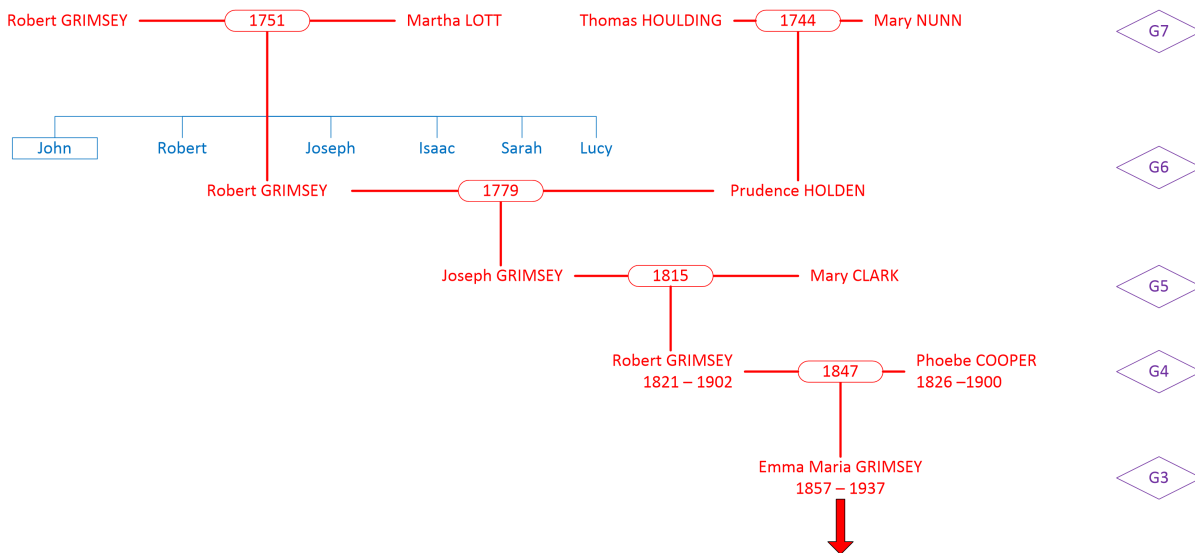

John GRIMSEY (1752 – 1813) m 1777 Hannah ALLEN (1752 – 1780)

Sarah GRIMSEY (1805)

Sarah GRIMSEY (1778 – 1814) — 1803 — Joseph DAWSON (? – ?)

- 1804 — Sarah Ann
- 1805 — Sarah Ann
- 1805 — Joseph
- 1807 — John Grimsey
- 1808 — Hannah Allen
- 1810 — Isaac
- 1811 — Susannah Smith

088L  
John GRIMSEY  
1752 – 1813

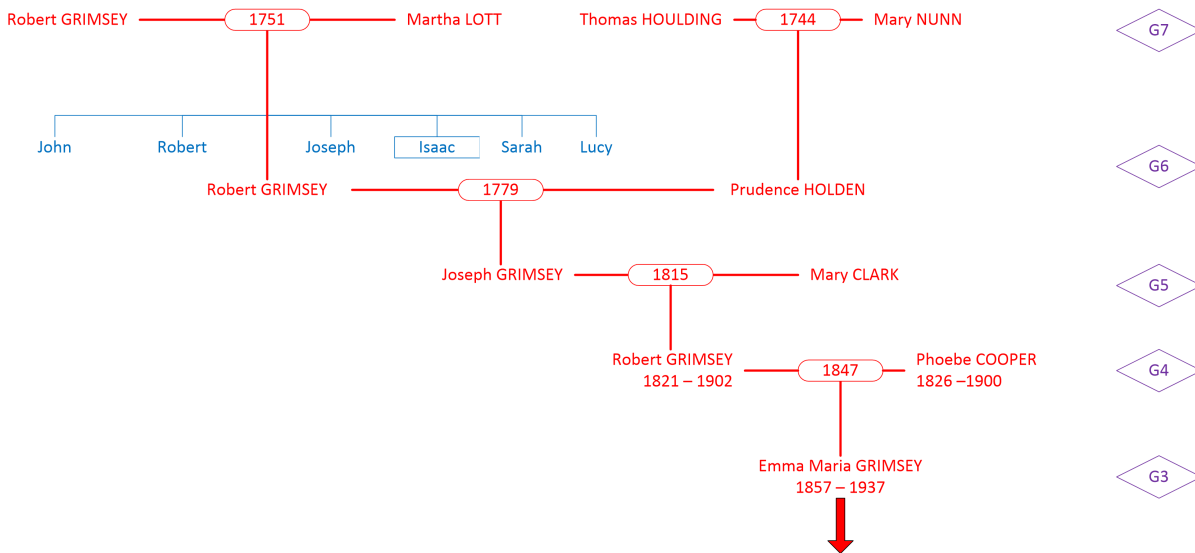

Isaac GRIMSEY (1758 – 1814) m 1803 Susan GOLDACRE (1760 – ?)

0880  
Isaac GRIMSEY  
1758 – 1814

1804 – 1804 — Isaac

1805 – 1856 — Susanne m 1826 Nicholas GRIMSEY

